

驾驶室液压举升 Cabin Tilting Cylinder & Pump



SORL[®]



Company Introduction 企业介绍

Founded in 1987, Ruili Group has more than 20 wholly-owned, holding and shareholding enterprises span manufacturing and service industries. The manufacturing industry of Ruili is mainly engaged in the research and development, manufacturing and sales of auto parts and rail transit parts. Rail transit parts manufactured by Ruili are widely used in CHSR, CRH, urban rail and metro. Ruili products featured in Beijing Olympic Games, Shanghai World Exposition, 60th and 70th National Day Parade, 70th Anniversary Parade of the Victory of the Anti-Japanese War, 90th Anniversary Parade of the Military Founding.

Ruili group has been named the China Top 100 Auto Parts Enterprises, the National Auto Parts Export Base, the Key High-tech Enterprise of National Torch Plan, the National Intellectual Property Demonstration Enterprise, the National Top 500 Private Enterprises, the Zhejiang Top 100 Manufacturing Industry Enterprises, the Zhejiang Leading Industry Enterprise, the Zhejiang Leading Innovation Enterprise, the Zhejiang Leading High-end Equipment Manufacturing Enterprise, the Zhejiang "Three Famous" Cultivate Pilot Enterprise, the Zhejiang Advanced Unit of Valuing and caring Talents.

Ruili under the instruction of thinking decide way out, strategic achieve future, detail decides success or failure, has formed a business pattern that manufacturing industry with professional management for diversified operation and investment, now has developed as an enterprise group that auto parts predominating, also take the real estate, hotel services, business, trade, culture and education into account.

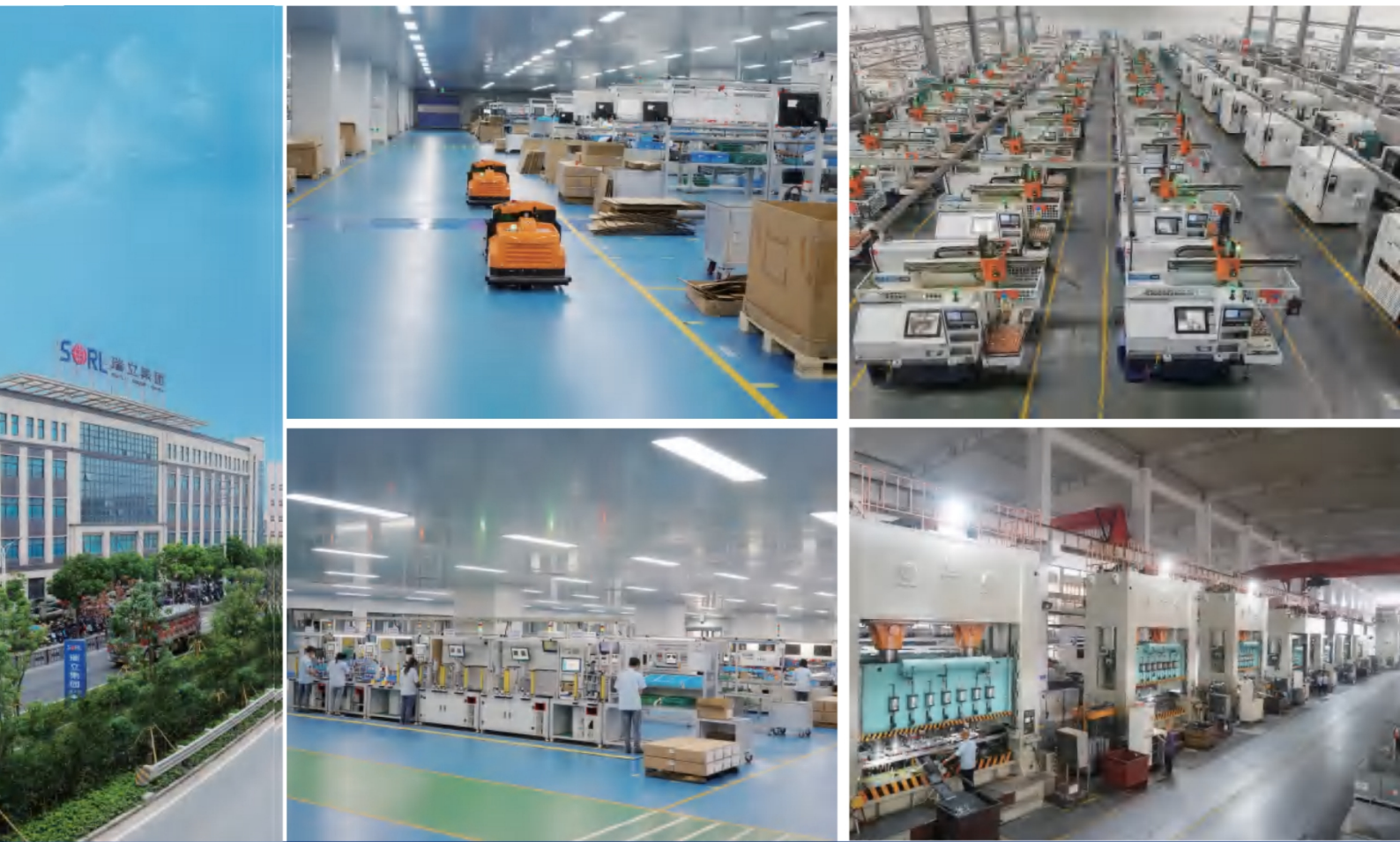

瑞立集团创办于1987年，旗下现有全资、控股、参股企业20余家，产业跨越制造业、服务业。集团二产板块主要从事汽车零部件、轨道车辆零部件的研发、制造和销售。瑞立制造的轨道车辆零部件在高铁、动车、城轨、地铁上广泛应用。北京奥运会、上海世博会、国庆60周年阅兵、抗战胜利70周年阅兵、建军90周年阅兵，国庆70周年阅兵大会上，都有瑞立产品的身影。

瑞立先后被命名为中国汽车零部件百强企业、国家汽车零部件出口基地企业、国家火炬计划重点高新技术企业、国家知识产权示范企业、全国民营企业500强、浙江省制造业百强、浙江省工业行业龙头骨干企业、浙江省创新型领军企业、浙江省高端装备制造业骨干企业、浙江省“三名”培育试点企业、浙江省“重才爱才”先进单位。

瑞立在“思路决定出路、战略成就未来、细节决定成败”的发展理念指引下，形成了“一业为主、适度多元经营，多元投资、专业管理”格局，现已经发展成为主营汽配，兼跨房地产、酒店服务、商业、贸易、文教等为一体的无区域企业集团。



瑞立举升泵分厂 Ruili Tilting Pump Plant

瑞立举升泵分厂前身为温州市金斯太汽车配件厂，创办于1988年10月，为国内最早生产驾驶室翻转油缸和手动液压泵的民营企业之一，是集重型汽车零部件开发、制造和销售为一体的公司。2017年12月正式加入瑞立集团。

自2019年6月搬至海安厂区，已形成自身的核心技术，建立了一套科学的管理体系，拥有一支有着丰富经验和专业技能的生产骨干团队，并加强了对产品质量的全程管理，给予了产品每一道工序的严检要求。分厂严格贯彻ISO/TS16949国际质量体系认证，拥有行业先进的加工及检测设备，如自动珩磨机、自动走心机、立式加工中心、钻攻中心、数控钻铣中心、三坐标测量仪、金属元素分析仪、三维震动试验台、液压举升模拟耐久试验台、随动试验机、高低温湿度试验台及泥水粉尘试验台等，同时还拥有全自动超声波清洗线、半自动装配线、半自动喷漆线及自动检测台，目前已具备年产20万套驾驶室翻转系统产品的生产能力。

产品涵盖了重汽、一汽、二汽、福田等国内众多品牌及斯堪尼亚、奔驰、沃尔沃、雷诺、曼等国际产品，已销售至欧洲、非洲、南美洲、中东、东南亚等30多个国家和地区。

Ruili Cabin Pump plant, formerly known as Wenzhou Jintai auto parts factory, which was founded in October 1988. It is one of the earliest private enterprises in China to produce Cab Tilting Cylinder and Manual Hydraulic Pump. It is a company integrating development, manufacturing and sales of heavy duty vehicle parts. The factory was acquired completely by Ruili Group in December 2017.

Since moving to Hai'an plant in June 2019, it has formed its own core technology, established a set of scientific management system, has a production backbone team with rich experience and professional skills, and strengthened the whole process management of product quality. The plant is operated strictly according to ISO/TS 16949, and has advanced processing and testing equipment in the industry, such as automatic quilting mill, automatic walking machine, vertical machining center, drilling and tapping center, NC drilling and milling center, CMM, metal element analyzer, three-dimensional vibration test bench, hydraulic lifting simulation durability test bench, follow-up test machine. Meanwhile, it also has a full-automatic ultrasonic cleaning line, semi-automatic assembly line, semi-automatic painting line and automatic detection platform. At present, it has an annual production capacity of 200,000 sets of cab lift system products.

The application covers not only domestic brands like FAW, Dongfeng and Foton, but also international brands such as Scania, Mercedes Benz, Volvo, Renault and Man. Products are sold to more than 30 countries and regions such as Europe, Africa, South America, Middle East and Southeast Asia.



Equipment



车间概况

Workshop Profiles

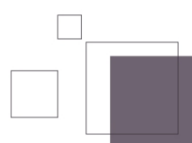

GLOBAL APPLICATIONS

国际车型

SCANIA	斯堪尼亚系列	1
MERCEDES BENZ	奔驰系列	6
VOLVO	沃尔沃系列	12
RENAULT	雷诺系列	16
DAF	达夫系列	18
MAN	曼系列	20
IVECO	依维柯系列	21
KAMAZ	卡玛斯系列	24
JAPANESE TRUCKS	日系系列	25
KOREAN TRUCKS	韩系系列	29
AMERICAN INTERNATIONAL	美系系列	31

CHINESE APPLICATIONS

国内车型

SINOTRUK	重汽系列	32
FAW JIEFANG	一汽系列	43
DONGFENG	二汽系列	60
FOTON	福田系列	70
LIUZHOU AUTO	柳汽系列	75
JAC	江淮系列	79
SHACHMAN	陕汽系列	82
NORTH BENZ	北奔系列	89
SANY	三一系列	95
SAIC-IVECO HONGYAN	上汽红岩系列	96
DAYUN	大运系列	98
CAMC	华菱系列	101
XCMG	徐工系列	106
C&C TRUCKS	联合卡车系列	107
OTHER BRANDS	其它系列	109

SERIES SCANIA 斯堪尼亚系列



SORL NO. 5003 140 159 0

DESCRIPTION	FOR	OEM NO.
Cabin Tilting Cylinder 举升缸	SCANIA 斯堪尼亚	1720927 1511922

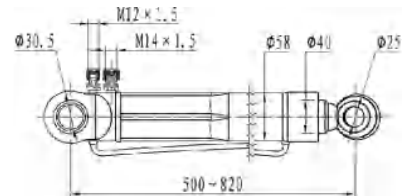

SORL NO. 5003 140 161 0

DESCRIPTION	FOR	OEM NO.
Cabin Tilting Cylinder 举升缸	SCANIA 斯堪尼亚	1720924 1477878

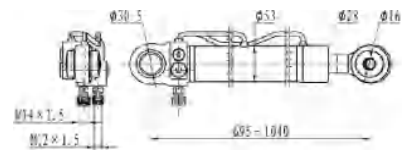

SORL NO. 5003 140 162 0

DESCRIPTION	FOR	OEM NO.
Cabin Tilting Cylinder 举升缸	SCANIA 斯堪尼亚	1720925 1512253

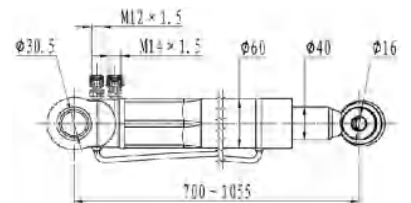

SORL NO. 5003 140 163 0

DESCRIPTION	FOR	OEM NO.
Cabin Tilting Cylinder 举升缸	SCANIA 斯堪尼亚	1549737 1477876

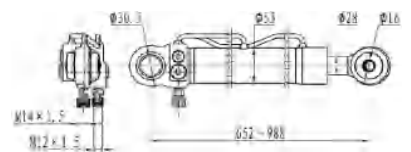

SORL NO. 5003 140 189 0

DESCRIPTION	FOR	OEM NO.
Cabin Tilting Cylinder 举升缸	SCANIA 斯堪尼亚	1549739 1517325 1511921 1423397 1466507 1354889 1720926 575206

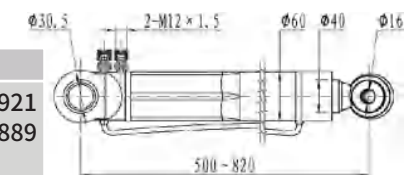



SORL NO. 5003 140 190 0

DESCRIPTION	FOR	OEM NO.
Cabin Tilting Cylinder 举升缸	SCANIA 斯堪尼亚	375351 575172

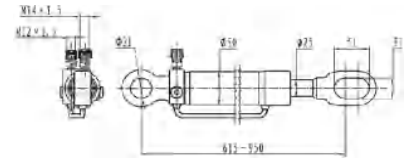

SORL NO. 5003 140 192 0

DESCRIPTION	FOR	OEM NO.
Cabin Tilting Cylinder 举升缸	SCANIA 斯堪尼亚	375350 10575171 1575171

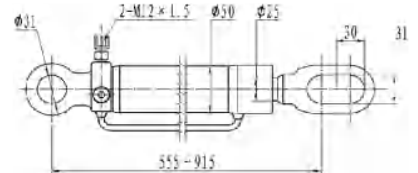

SORL NO. 5003 140 193 0

DESCRIPTION	FOR	OEM NO.
Cabin Tilting Cylinder 举升缸	SCANIA 斯堪尼亚	382386 575173

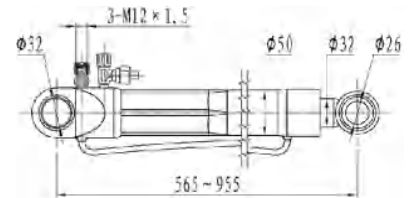

SORL NO. 5003 140 196 0

DESCRIPTION	FOR	OEM NO.
Cabin Tilting Cylinder 举升缸	SCANIA 斯堪尼亚	1575173

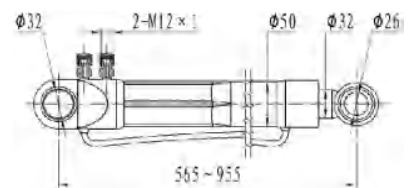

SORL NO. 5003 140 197 0

DESCRIPTION	FOR	OEM NO.
Cabin Tilting Cylinder 举升缸	SCANIA 斯堪尼亚	1848921

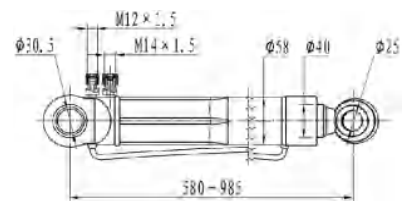

SORL NO. 5003 150 023 0

DESCRIPTION	FOR	OEM NO.
Cabin Tilting Cylinder 举升缸	SCANIA 斯堪尼亚	1549738 1517324 1466506 1354888 575102 575205 575163

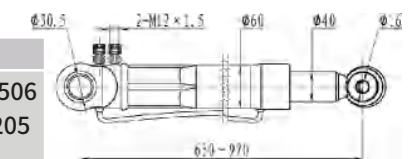



SORL NO. 5003 316 102 0

DESCRIPTION	FOR	OEM NO.
Cabin Tilting Pump 举升泵	SCANIA 斯堪尼亚	1549740 1397310 1575165

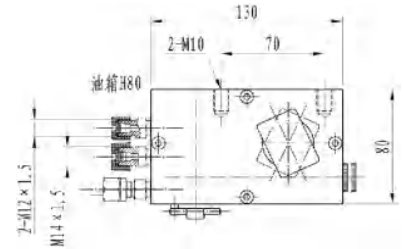

SORL NO. 5003 316 103 0

DESCRIPTION	FOR	OEM NO.
Cabin Tilting Pump 举升泵	SCANIA 斯堪尼亚	1794907

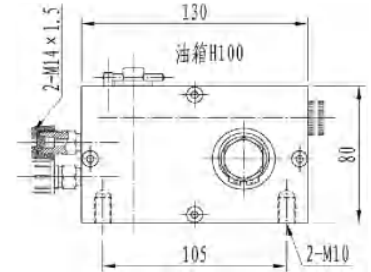

SORL NO. 5003 316 213 0

DESCRIPTION	FOR	OEM NO.
Cabin Tilting Pump 举升泵	SCANIA 斯堪尼亚	1549741 1477847

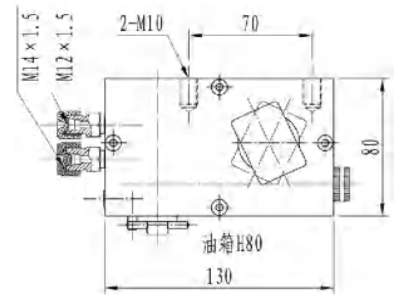

SORL NO. 5003 316 226 0

DESCRIPTION	FOR	OEM NO.
Cabin Tilting Pump 举升泵	SCANIA 斯堪尼亚	1378527 368926 575153

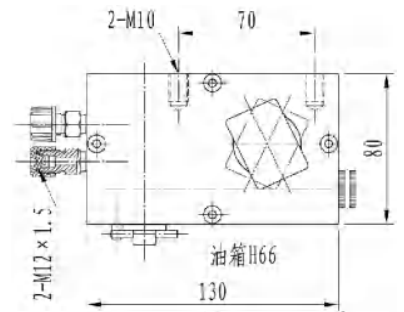

SORL NO. 5003 316 227 0

DESCRIPTION	FOR	OEM NO.
Cabin Tilting Pump 举升泵	SCANIA 斯堪尼亚	1314653 575159

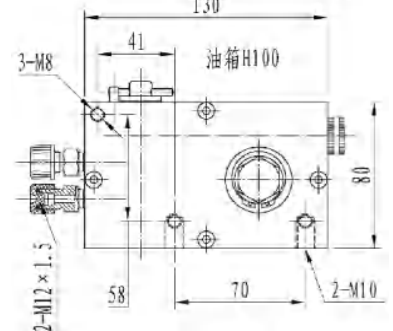

SORL NO. 5003 316 237 0

DESCRIPTION	FOR	OEM NO.
Cabin Tilting Pump 举升泵	SCANIA 斯堪尼亚	1375497 1349010 575160

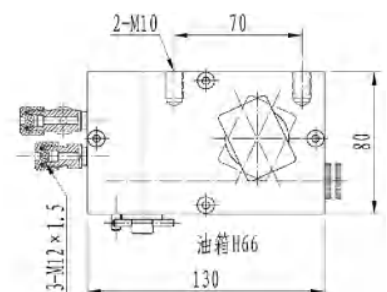



SORL NO. 5003 316 278 0

DESCRIPTION	FOR	OEM NO.
Cabin Tilting Pump 举升泵	SCANIA 斯堪尼亚	394330

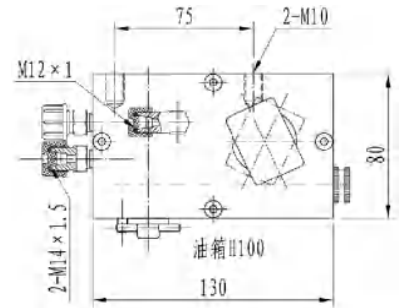

SORL NO. 5003 316 279 0

DESCRIPTION	FOR	OEM NO.
Cabin Tilting Pump 举升泵	SCANIA 斯堪尼亚	

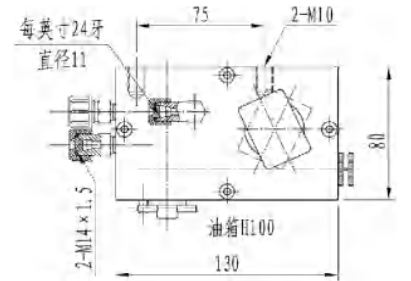

SORL NO. 5003 316 280 0

DESCRIPTION	FOR	OEM NO.
Cabin Tilting Pump 举升泵	SCANIA 斯堪尼亚	

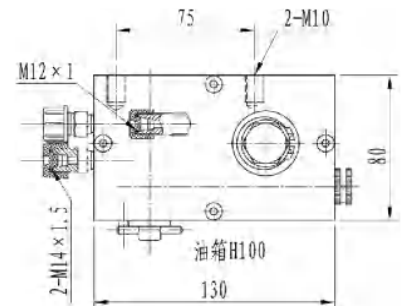

SORL NO. 5003 316 281 0

DESCRIPTION	FOR	OEM NO.
Cabin Tilting Pump 举升泵	SCANIA 斯堪尼亚	1534976 1725376

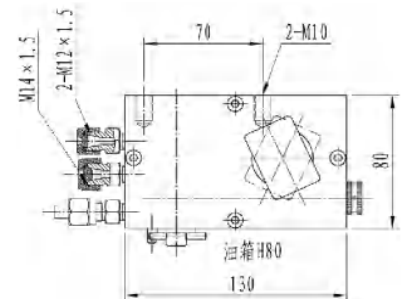

SORL NO. 5003 316 282 0

DESCRIPTION	FOR	OEM NO.
Cabin Tilting Pump 举升泵	SCANIA 斯堪尼亚	

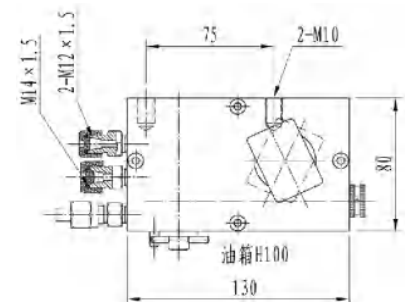

SORL NO. 5003 316 283 0

DESCRIPTION	FOR	OEM NO.
Cabin Tilting Pump 举升泵	SCANIA 斯堪尼亚	

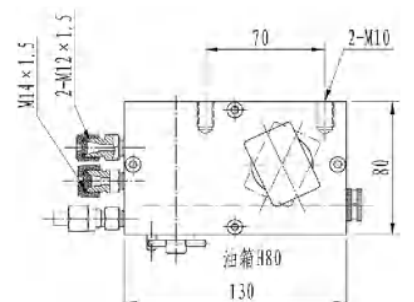



SORL NO. 5003 316 284 0

DESCRIPTION	FOR	OEM NO.
Cabin Tilting Pump 举升泵	SCANIA 斯堪尼亚	

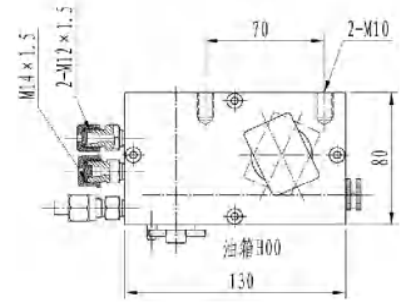

SORL NO. 5003 316 285 0

DESCRIPTION	FOR	OEM NO.
Cabin Tilting Pump 举升泵	SCANIA 斯堪尼亚	

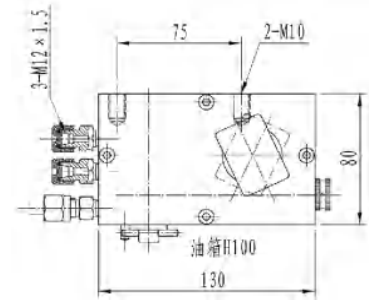

SORL NO. 5003 316 286 0

DESCRIPTION	FOR	OEM NO.
Cabin Tilting Pump 举升泵	SCANIA 斯堪尼亚	1378531 361453 383524 575152 575154

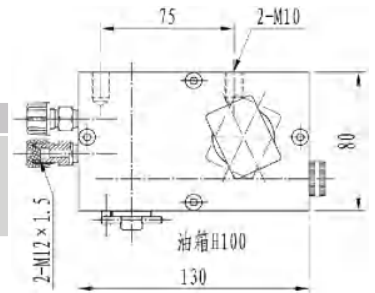

SORL NO. 5003 316 287 0

DESCRIPTION	FOR	OEM NO.
Cabin Tilting Pump 举升泵	SCANIA 斯堪尼亚	

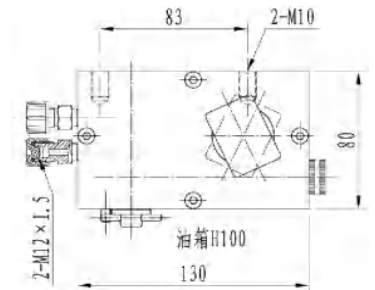

SORL NO. 5003 316 288 0

DESCRIPTION	FOR	OEM NO.
Cabin Tilting Pump 举升泵	SCANIA 斯堪尼亚	

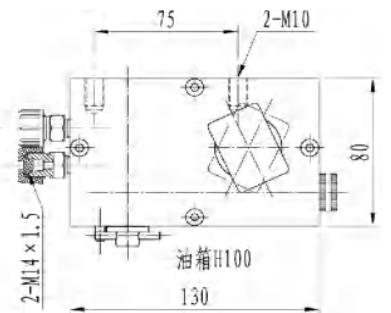

SORL NO. 5003 316 289 0

DESCRIPTION	FOR	OEM NO.
Cabin Tilting Pump 举升泵	SCANIA 斯堪尼亚	

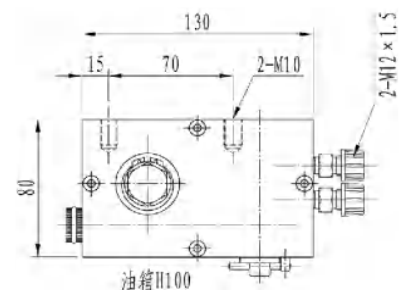



SORL NO. 5003 316 290 0

DESCRIPTION	FOR	OEM NO.
Cabin Tilting Pump 举升泵	SCANIA 斯堪尼亚	

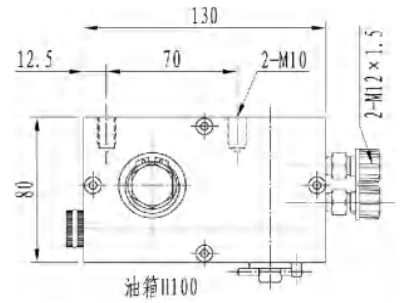

SORL NO. 5003 316 291 0

DESCRIPTION	FOR	OEM NO.
Cabin Tilting Pump 举升泵	SCANIA 斯堪尼亚	

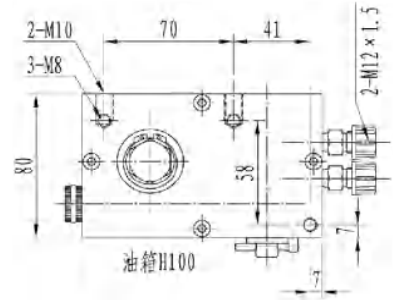

SORL NO. 5003 316 292 0

DESCRIPTION	FOR	OEM NO.
Cabin Tilting Pump 举升泵	SCANIA 斯堪尼亚	1794907

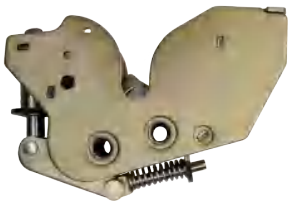
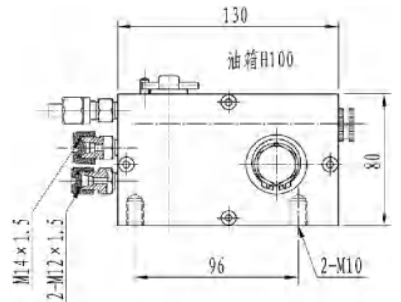

SORL NO. 5004 C15 006 0

DESCRIPTION	FOR	OEM NO.
Cabin Latch 液压锁	SCANIA 斯堪尼亚	

SERIES MERCEDES BENZ 奔驰系列



SORL NO. 5003 140 020 0

DESCRIPTION	FOR	OEM NO.
Cabin Tilting Cylinder 举升缸	MERCEDES BENZ 奔驰	0015534305 0015531005 3715537105

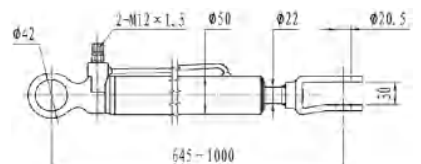



SORL NO. 5003 140 172 0

DESCRIPTION	FOR	OEM NO.
Cabin Tilting Cylinder 举升缸	MERCEDES BENZ 奔驰	0015533605 0005534405 0005537005 0005532805 0005536805

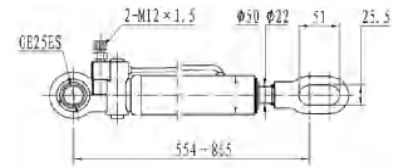

SORL NO. 5003 140 173 0

DESCRIPTION	FOR	OEM NO.
Cabin Tilting Cylinder 举升缸	MERCEDES BENZ 奔驰	0025539205 0025537805

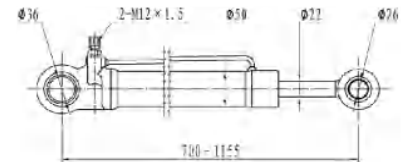

SORL NO. 5003 140 174 0

DESCRIPTION	FOR	OEM NO.
Cabin Tilting Cylinder 举升缸	MERCEDES BENZ 奔驰	0025538505

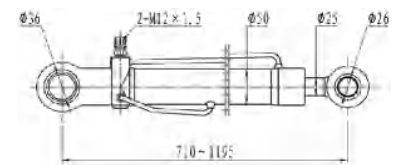

SORL NO. 5003 140 175 0

DESCRIPTION	FOR	OEM NO.
Cabin Tilting Cylinder 举升缸	MERCEDES BENZ 奔驰	0025538205

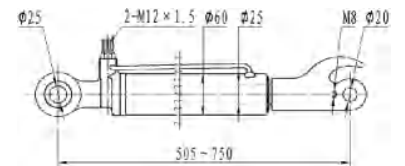

SORL NO. 5003 140 176 0

DESCRIPTION	FOR	OEM NO.
Cabin Tilting Cylinder 举升缸	MERCEDES BENZ 奔驰	0025537705 0025535705 0025539105

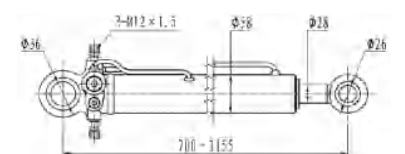

SORL NO. 5003 140 177 0

DESCRIPTION	FOR	OEM NO.
Cabin Tilting Cylinder 举升缸	MERCEDES BENZ 奔驰	0015534705 0005537805

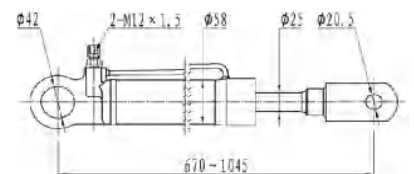



SORL NO. 5003 140 178 0

DESCRIPTION	FOR	OEM NO.
Cabin Tilting Cylinder 举升缸	MERCEDES BENZ 奔驰	0025536805

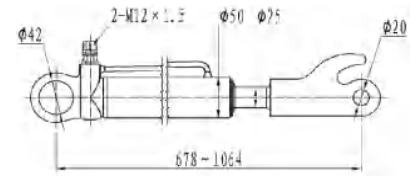

SORL NO. 5003 140 179 0

DESCRIPTION	FOR	OEM NO.
Cabin Tilting Cylinder 举升缸	MERCEDES BENZ 奔驰	0025538805 0025536605 0025538405 0025535405

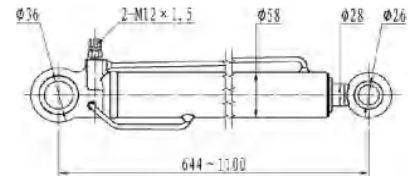

SORL NO. 5003 140 180 0

DESCRIPTION	FOR	OEM NO.
Cabin Tilting Cylinder 举升缸	MERCEDES BENZ 奔驰	0025534405

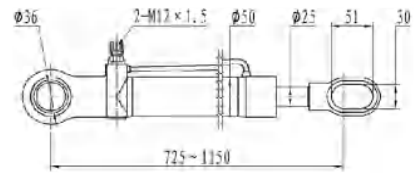

SORL NO. 5003 140 181 0

DESCRIPTION	FOR	OEM NO.
Cabin Tilting Cylinder 举升缸	MERCEDES BENZ 奔驰	9735530005

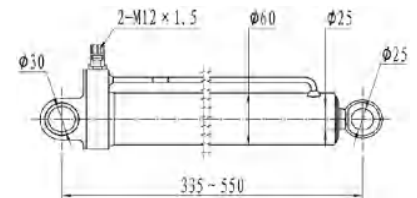

SORL NO. 5003 140 182 0

DESCRIPTION	FOR	OEM NO.
Cabin Tilting Cylinder 举升缸	MERCEDES BENZ 奔驰	0015538705

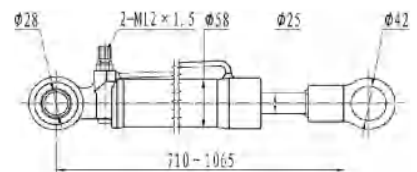

SORL NO. 5003 140 233 0

DESCRIPTION	FOR	OEM NO.
Cabin Tilting Cylinder 举升缸	MERCEDES BENZ 奔驰	0025535205 0025531805

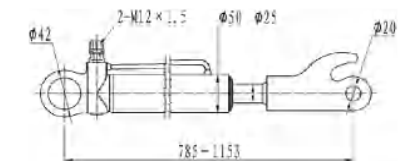



SORL NO. 5003 145 001 0

DESCRIPTION	FOR	OEM NO.
Cabin Tilting Cylinder 举升缸	MERCEDES BENZ 奔驰	0025531005 0025530905 0025531305 0025531405

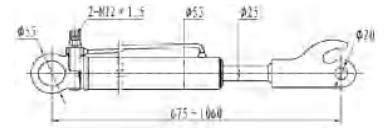

SORL NO. 5003 145 006 0

DESCRIPTION	FOR	OEM NO.
Cabin Tilting Cylinder 举升缸	MERCEDES BENZ 奔驰	0025531405 0025530905

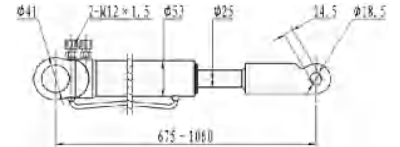

SORL NO. 5003 150 041 0

DESCRIPTION	FOR	OEM NO.
Cabin Tilting Cylinder 举升缸	MERCEDES BENZ 奔驰	0015534505 0005538705

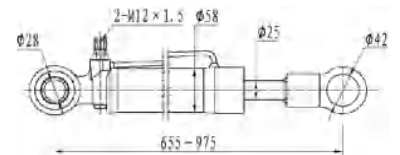

SORL NO. 5003 150 043 0

DESCRIPTION	FOR	OEM NO.
Cabin Tilting Cylinder 举升缸	MERCEDES BENZ 奔驰	0015534605 0005533205 0005537505 0005534605 0005533705

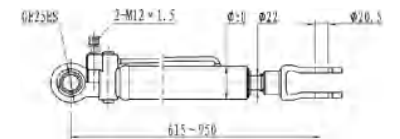

SORL NO. 5003 316 211 0

DESCRIPTION	FOR	OEM NO.
Cabin Tilting Pump 举升泵	MERCEDES BENZ 奔驰	0015533801

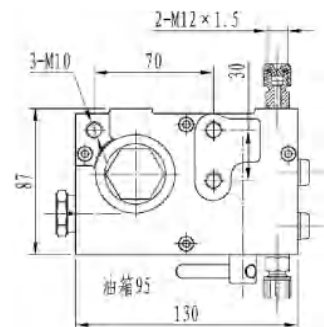

SORL NO. 5003 316 214 0

DESCRIPTION	FOR	OEM NO.
Cabin Tilting Pump 举升泵	MERCEDES BENZ 奔驰	0015530001 0015535901 3755530001 9585530201/001

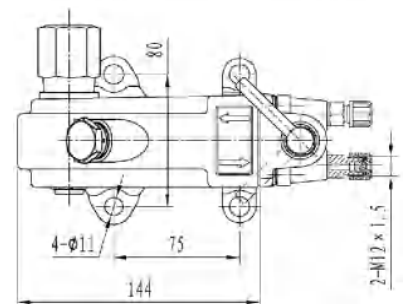



SORL NO. 5003 316 217 0

DESCRIPTION	FOR	OEM NO.
Cabin Tilting Pump 举升泵	MERCEDES BENZ 奔驰	0015533601

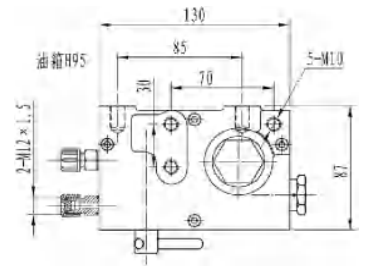

SORL NO. 5003 316 228 0

DESCRIPTION	FOR	OEM NO.
Cabin Tilting Pump 举升泵	MERCEDES BENZ 奔驰	0015533901

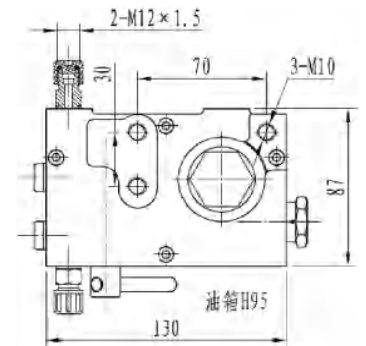

SORL NO. 5003 316 229 0

DESCRIPTION	FOR	OEM NO.
Cabin Tilting Pump 举升泵	MERCEDES BENZ 奔驰	0015533701

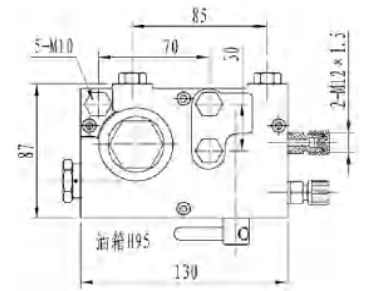

SORL NO. 5003 316 230 0

DESCRIPTION	FOR	OEM NO.
Cabin Tilting Pump 举升泵	MERCEDES BENZ 奔驰	0015533501

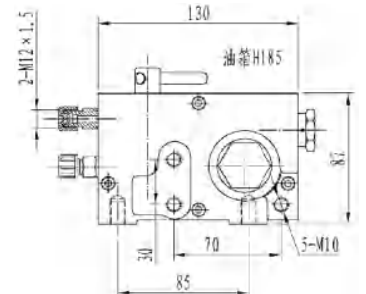

SORL NO. 5003 316 231 0

DESCRIPTION	FOR	OEM NO.
Cabin Tilting Pump 举升泵	MERCEDES BENZ 奔驰	0015533401

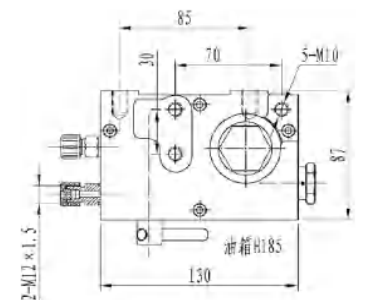

SORL NO. 5003 316 232 0

DESCRIPTION	FOR	OEM NO.
Cabin Tilting Pump 举升泵	MERCEDES BENZ 奔驰	0015534101

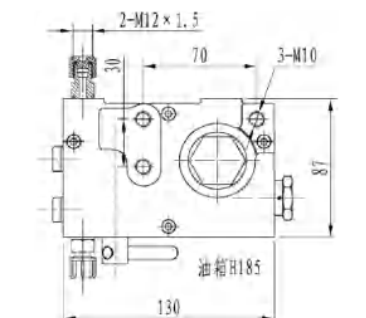

SORL NO. 5003 316 233 0



DESCRIPTION	FOR	OEM NO.
Cabin Tilting Pump 举升泵	MERCEDES BENZ 奔驰	0005537901 0005532701 0005534001 0005532301 0005533901 3715537001

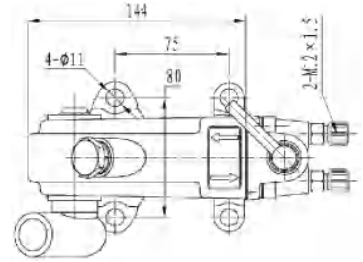

SORL NO. 5003 316 295 0



DESCRIPTION	FOR	OEM NO.
Cabin Tilting Pump 举升泵	MERCEDES BENZ 奔驰	

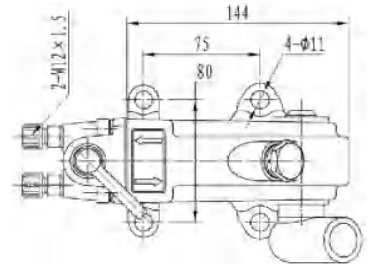

SORL NO. 5003 316 296 0



DESCRIPTION	FOR	OEM NO.
Cabin Tilting Pump 举升泵	MERCEDES BENZ 奔驰	0015539901 0015531401

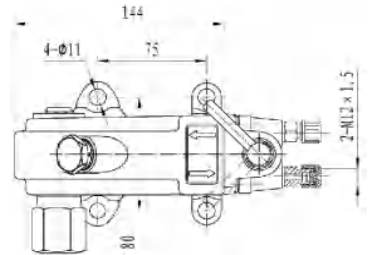

SORL NO. 5003 316 297 0



DESCRIPTION	FOR	OEM NO.
Cabin Tilting Pump 举升泵	MERCEDES BENZ 奔驰	

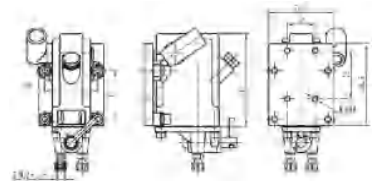

SORL NO. 5003 316 298 0



DESCRIPTION	FOR	OEM NO.
Cabin Tilting Pump 举升泵	MERCEDES BENZ 奔驰	

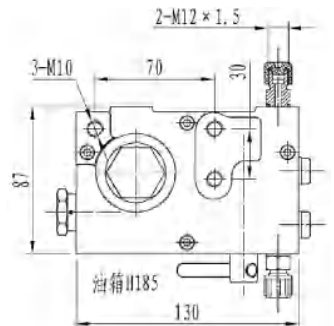

SORL NO. 5004 C6 010 0



DESCRIPTION	FOR	OEM NO.
Cabin Latch 液压锁	MERCEDES BENZ 奔驰	5183171116 00028814050034



SORL NO. 5004 C6 011 0

DESCRIPTION	FOR	OEM NO.
Cabin Latch 液压锁	MERCEDES BENZ 奔驰	5183171116 00028814050139

SERIES VOLVO 沃尔沃系列



SORL NO. 5003 140 158 0

DESCRIPTION	FOR	OEM NO.
Cabin Tilting Cylinder 举升缸	VOLVO 沃尔沃	20922305 3198843

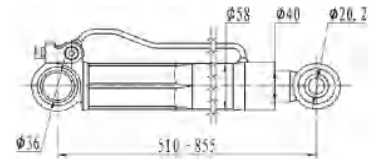

SORL NO. 5003 140 165 0

DESCRIPTION	FOR	OEM NO.
Cabin Tilting Cylinder 举升缸	VOLVO 沃尔沃	20922303

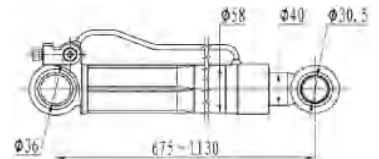

SORL NO. 5003 140 183 0

DESCRIPTION	FOR	OEM NO.
Cabin Tilting Cylinder 举升缸	VOLVO 沃尔沃	1082068 1571287 1584643 1609246 1609247 1610041

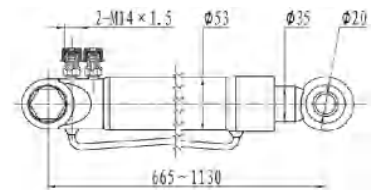

SORL NO. 5003 140 184 0

DESCRIPTION	FOR	OEM NO.
Cabin Tilting Cylinder 举升缸	VOLVO 沃尔沃	1605935 1611872

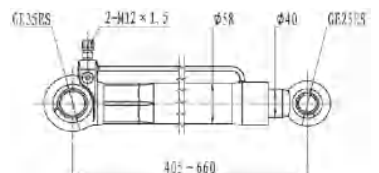

**SORL NO. 5003 140 185 0**

DESCRIPTION	FOR	OEM NO.
Cabin Tilting Cylinder 举升缸	VOLVO 沃尔沃	3944751 20452326 1075233

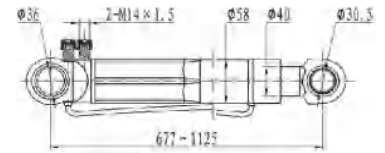
**SORL NO. 5003 140 186 0**

DESCRIPTION	FOR	OEM NO.
Cabin Tilting Cylinder 举升缸	VOLVO 沃尔沃	8150551

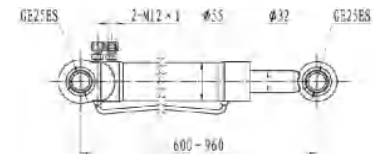
**SORL NO. 5003 140 187 0**

DESCRIPTION	FOR	OEM NO.
Cabin Tilting Cylinder 举升缸	VOLVO 沃尔沃	3198842

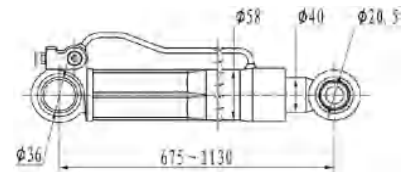
**SORL NO. 5003 140 188 0**

DESCRIPTION	FOR	OEM NO.
Cabin Tilting Cylinder 举升缸	VOLVO 沃尔沃	1075457 20409130

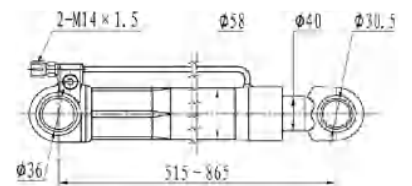
**SORL NO. 5003 150 050 0**

DESCRIPTION	FOR	OEM NO.
Cabin Tilting Cylinder 举升缸	VOLVO 沃尔沃	3198843

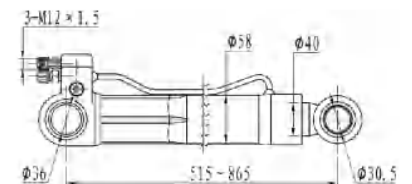
**SORL NO. 5003 316 075 0**

DESCRIPTION	FOR	OEM NO.
Cabin Tilting Pump 举升泵	VOLVO 沃尔沃	3198846 20455262 20917279 20917267

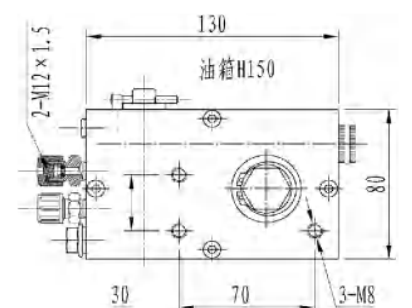

**SORL NO. 5003 316 198 0**

DESCRIPTION	FOR	OEM NO.
Cabin Tilting Pump 举升泵	VOLVO 沃尔沃	1611186

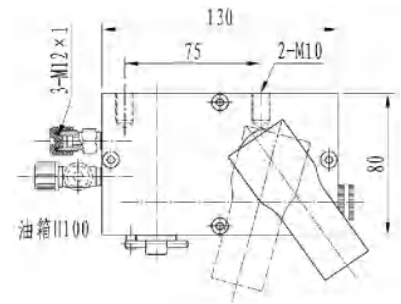
**SORL NO. 5003 316 209 0**

DESCRIPTION	FOR	OEM NO.
Cabin Tilting Pump 举升泵	VOLVO 沃尔沃	1075296

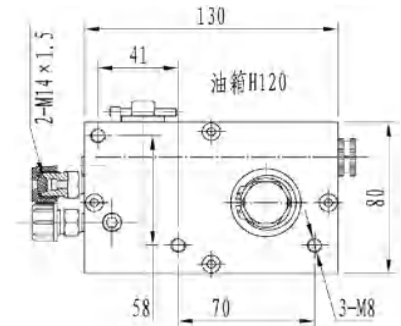
**SORL NO. 5003 316 234 0**

DESCRIPTION	FOR	OEM NO.
Cabin Tilting Pump 举升泵	VOLVO 沃尔沃	20455261

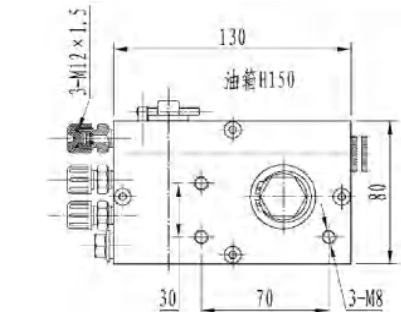
**SORL NO. 5003 316 235 0**

DESCRIPTION	FOR	OEM NO.
Cabin Tilting Pump 举升泵	VOLVO 沃尔沃	1075295 1095004

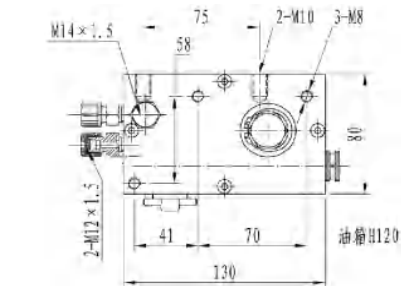
**SORL NO. 5003 316 236 0**

DESCRIPTION	FOR	OEM NO.
Cabin Tilting Pump 举升泵	VOLVO 沃尔沃	25379038 82053296

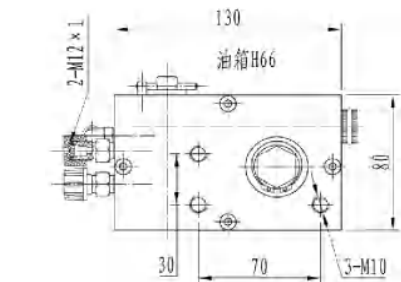
**SORL NO. 5003 316 293 0**

DESCRIPTION	FOR	OEM NO.
Cabin Tilting Pump 举升泵	VOLVO 沃尔沃	20455259 20917278 20917265 3198844

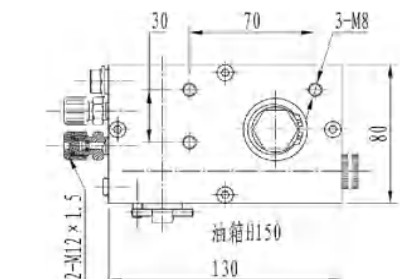

**SORL NO. 5003 316 299 0**

DESCRIPTION	FOR	OEM NO.
Cabin Tilting Pump 举升泵	VOLVO 沃尔沃	1095005

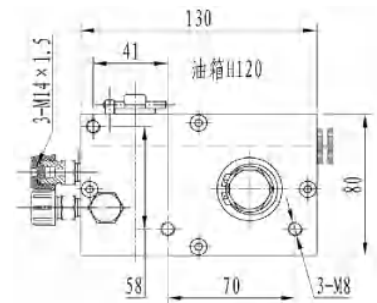
**SORL NO. 5003 316 300 0**

DESCRIPTION	FOR	OEM NO.
Cabin Tilting Pump 举升泵	VOLVO 沃尔沃	3943332 8151731

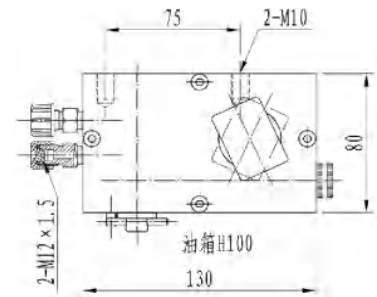
**SORL NO. 5003 316 301 0**

DESCRIPTION	FOR	OEM NO.
Cabin Tilting Pump 举升泵	VOLVO 沃尔沃	

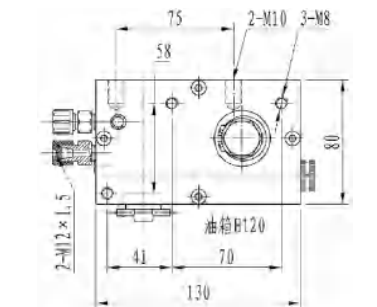
**SORL NO. 5003 316 302 0**

DESCRIPTION	FOR	OEM NO.
Cabin Tilting Pump 举升泵	VOLVO 沃尔沃	3943330

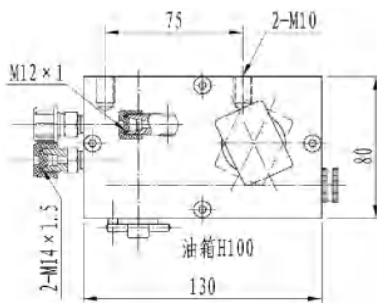
**SORL NO. 5003 316 303 0**

DESCRIPTION	FOR	OEM NO.
Cabin Tilting Pump 举升泵	VOLVO 沃尔沃	82053294

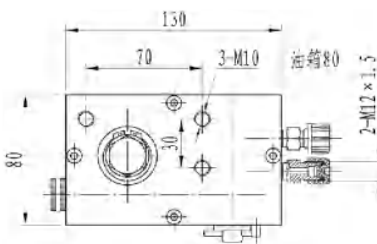

SERIES RENAULT 雷诺系列



SORL NO. 5003 140 204 0

DESCRIPTION	FOR	OEM NO.
Cabin Tilting Cylinder 举升缸	RENAULT 雷诺	5010316495

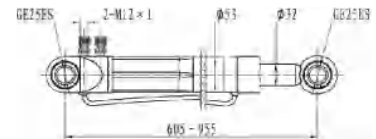

SORL NO. 5003 140 205 0

DESCRIPTION	FOR	OEM NO.
Cabin Tilting Cylinder 举升缸	RENAULT 雷诺	5010316793

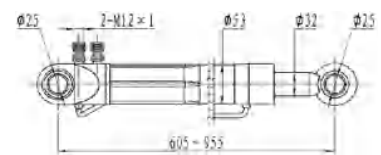

SORL NO. 5003 140 207 0

DESCRIPTION	FOR	OEM NO.
Cabin Tilting Cylinder 举升缸	RENAULT 雷诺	5000790046

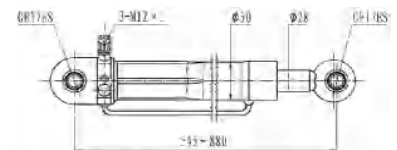

SORL NO. 5003 140 208 0

DESCRIPTION	FOR	OEM NO.
Cabin Tilting Cylinder 举升缸	RENAULT 雷诺	5000790047

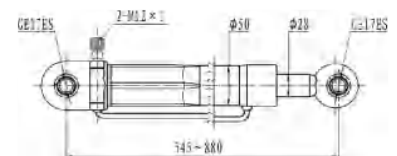

SORL NO. 5003 316 116 0

DESCRIPTION	FOR	OEM NO.
Cabin Tilting Pump 举升泵	RENAULT 雷诺	5010316404

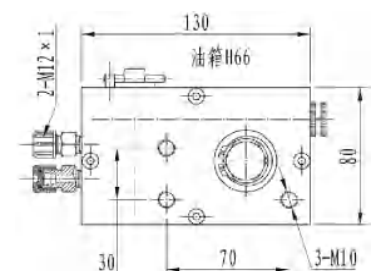



SORL NO. 5003 316 253 0

DESCRIPTION	FOR	OEM NO.
Cabin Tilting Pump 举升泵	RENAULT 雷诺	5010224942 5001858305 501022940

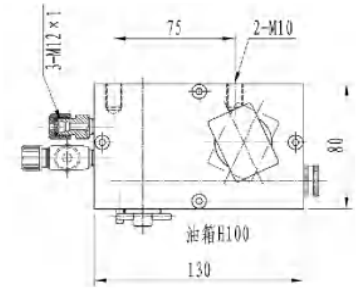

SORL NO. 5003 316 254 0

DESCRIPTION	FOR	OEM NO.
Cabin Tilting Pump 举升泵	RENAULT 雷诺	5010629361

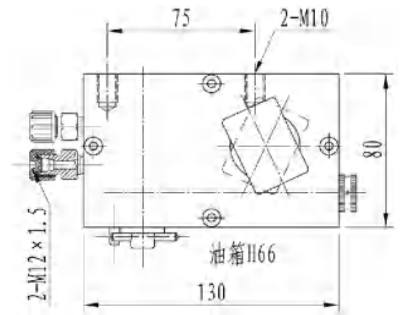

SORL NO. 5003 316 255 0

DESCRIPTION	FOR	OEM NO.
Cabin Tilting Pump 举升泵	RENAULT 雷诺	5010316438

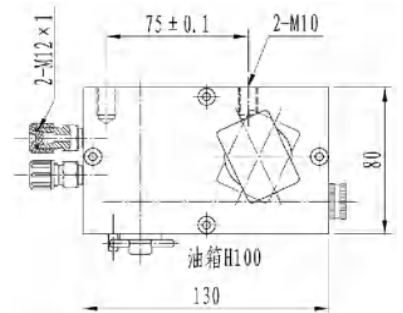

SORL NO. 5003 316 256 0

DESCRIPTION	FOR	OEM NO.
Cabin Tilting Pump 举升泵	RENAULT 雷诺	5010629349 7482053296

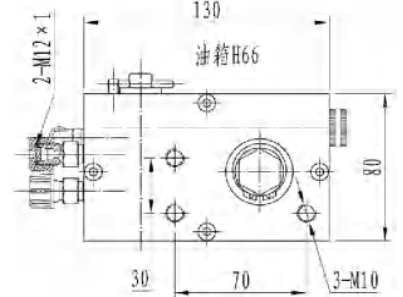

SORL NO. 5003 316 294 0

DESCRIPTION	FOR	OEM NO.
Cabin Tilting Pump 举升泵	RENAULT 雷诺	7482053294

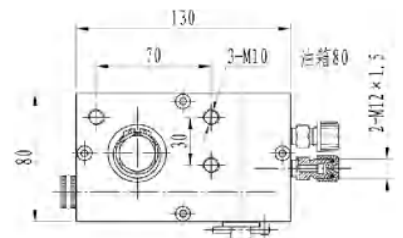

SORL NO. 5003 316 304 0

DESCRIPTION	FOR	OEM NO.
Cabin Tilting Pump 举升泵	RENAULT 雷诺	5010858305

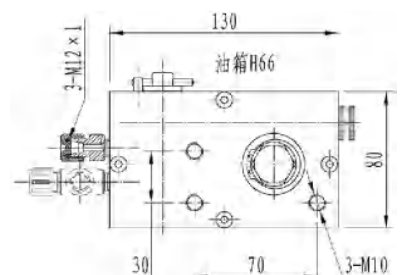

SERIES DAF 达夫系列



SORL NO. 5003 140 167 0

DESCRIPTION	FOR	OEM NO.
Cabin Tilting Cylinder 举升缸	DAF 达夫	

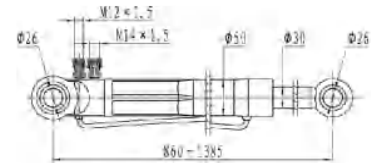

SORL NO. 5003 140 168 0

OEM NO.

DESCRIPTION	FOR	OEM NO.
Cabin Tilting Cylinder 举升缸	DAF 达夫	

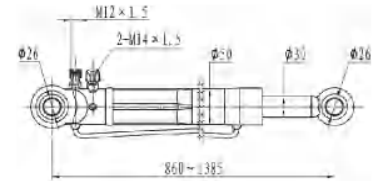

SORL NO. 5003 140 169 0

DESCRIPTION	FOR	OEM NO.
Cabin Tilting Cylinder 举升缸	DAF 达夫	1207525 1295729 1345473 85755

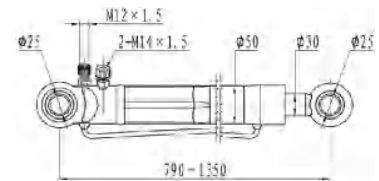

SORL NO. 5003 316 238 0

DESCRIPTION	FOR	OEM NO.
Cabin Tilting Pump 举升泵	DAF 达夫	1382283

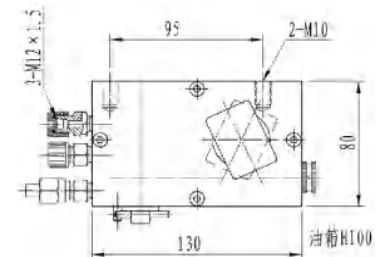

SORL NO. 5003 316 244 0

DESCRIPTION	FOR	OEM NO.
Cabin Tilting Pump 举升泵	DAF 达夫	372859

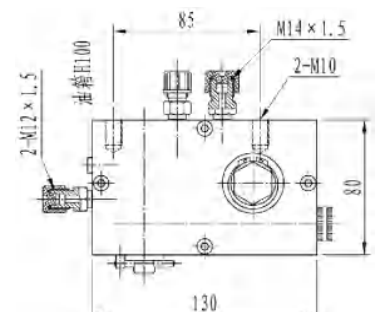



SORL NO. 5003 316 245 0

DESCRIPTION	FOR	OEM NO.
Cabin Tilting Pump 举升泵	DAF 达夫	372858

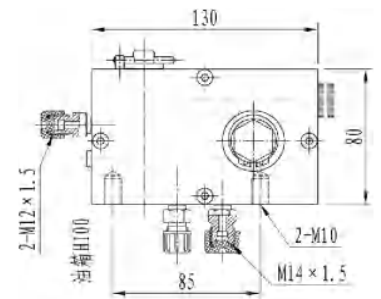

SORL NO. 5003 316 246 0

DESCRIPTION	FOR	OEM NO.
Cabin Tilting Pump 举升泵	DAF 达夫	1315942

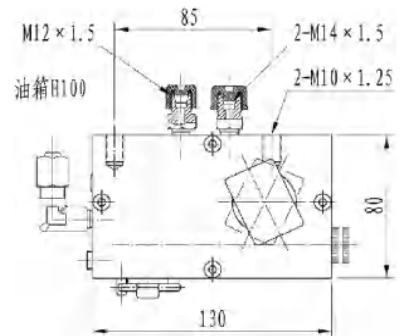

SORL NO. 5003 316 247 0

DESCRIPTION	FOR	OEM NO.
Cabin Tilting Pump 举升泵	DAF 达夫	1382282 1450902

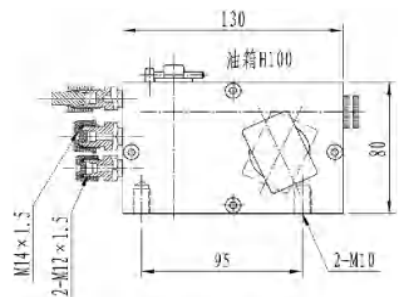

SORL NO. 5003 316 305 0

DESCRIPTION	FOR	OEM NO.
Cabin Tilting Pump 举升泵	DAF 达夫	1450903

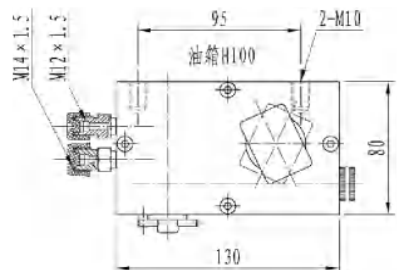

SORL NO. 5004 C15 005 0

DESCRIPTION	FOR	OEM NO.
Cabin Latch 液压锁	DAF 达夫	

SERIES MAN 曼系列



SORL NO. 5003 140 198 0

DESCRIPTION	FOR	OEM NO.
Cabin Tilting Cylinder 举升缸	MAN 曼	81417236076 81417239076

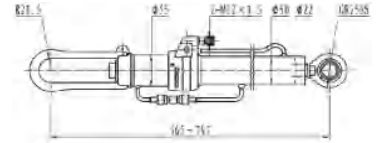

SORL NO. 5003 140 235 0

DESCRIPTION	FOR	OEM NO.
Cabin Tilting Cylinder 举升缸	MAN 曼	81417236124 85417236030 85417236010

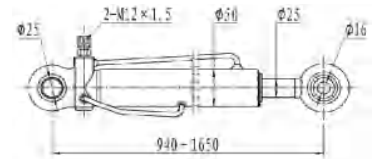

SORL NO. 5003 140 236 0

DESCRIPTION	FOR	OEM NO.
Cabin Tilting Cylinder 举升缸	MAN 曼	81417236123 85417236009 85417236029

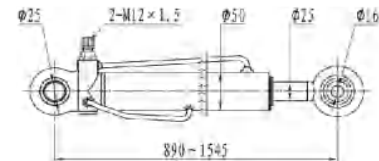

SORL NO. 5003 140 237 0

DESCRIPTION	FOR	OEM NO.
Cabin Tilting Cylinder 举升缸	MAN 曼	81417236099 83417236099

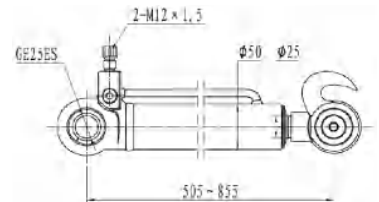

SORL NO. 5003 140 238 0

DESCRIPTION	FOR	OEM NO.
Cabin Tilting Cylinder 举升缸	MAN 曼	

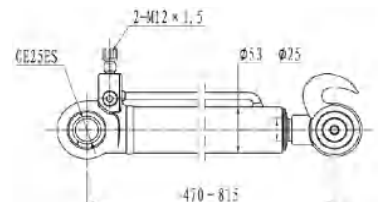



SORL NO. 5003 316 101 0

DESCRIPTION	FOR	OEM NO.
Cabin Tilting Pump 举升泵	MAN 曼	85417236011 85417236020 85417236044

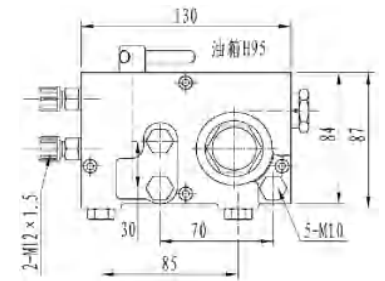

SORL NO. 5003 316 241 0

DESCRIPTION	FOR	OEM NO.
Cabin Tilting Pump 举升泵	MAN 曼	81417236026 81417236103 81417236114 81417239059

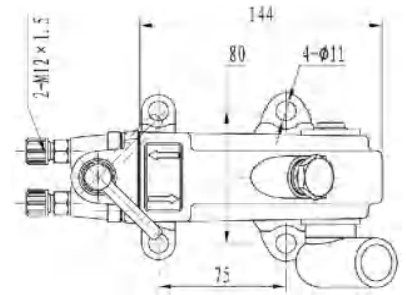

SORL NO. 5003 316 242 0

DESCRIPTION	FOR	OEM NO.
Cabin Tilting Pump 举升泵	MAN 曼	85417236014 85417236021 85417236043

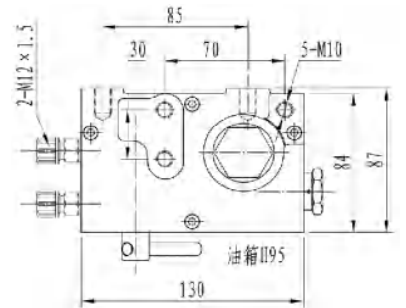

SORL NO. 5004 C15 003 0

DESCRIPTION	FOR	OEM NO.
Cabin Latch 液压锁	MAN 曼	85618516003

SERIES IVECO 依维柯系列



SORL NO. 5003 140 199 0

DESCRIPTION	FOR	OEM NO.
Cabin Tilting Cylinder 举升缸	IVECO 依维柯	500337311 504062817 41030419

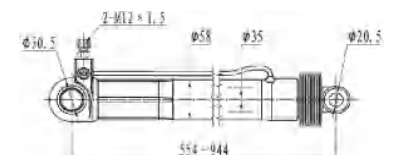



SORL NO. 5003 140 217 0

DESCRIPTION	FOR	OEM NO.
Cabin Tilting Cylinder 举升缸	IVECO 依维柯	8138252

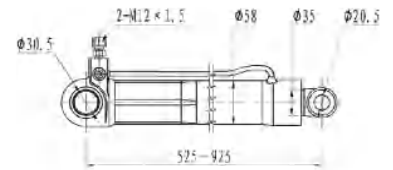

SORL NO. 5003 140 203 0

DESCRIPTION	FOR	OEM NO.
Cabin Tilting Cylinder 举升缸	IVECO 依维柯	500370651

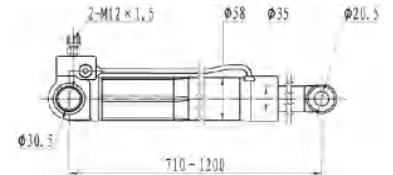

SORL NO. 5003 140 201 0

DESCRIPTION	FOR	OEM NO.
Cabin Tilting Cylinder 举升缸	IVECO 依维柯	504065532

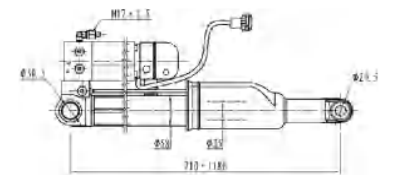

SORL NO. 5003 316 248 0

DESCRIPTION	FOR	OEM NO.
Cabin Tilting Pump 举升泵	IVECO 依维柯	99458304

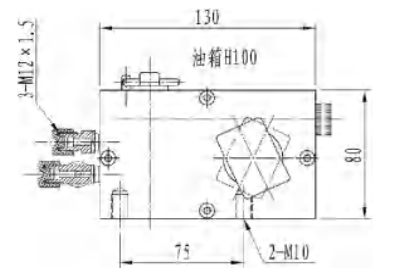

SORL NO. 5003 316 250 0

DESCRIPTION	FOR	OEM NO.
Cabin Tilting Pump 举升泵	IVECO 依维柯	500316981 504184573 99458298

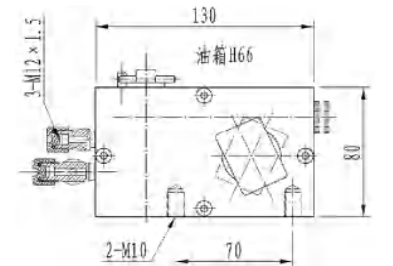

SORL NO. 5003 316 113 0

DESCRIPTION	FOR	OEM NO.
Cabin Tilting Pump 举升泵	IVECO 依维柯	41281222 504173053

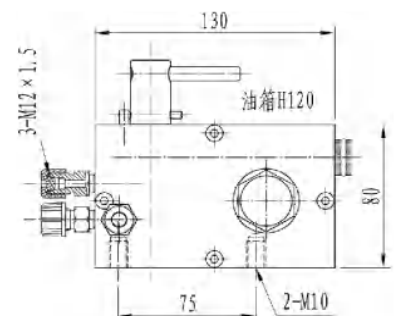

**SORL NO. 5003 316 251 0**

DESCRIPTION	FOR	OEM NO.
Cabin Tilting Pump 举升泵	IVECO 依维柯	4854244

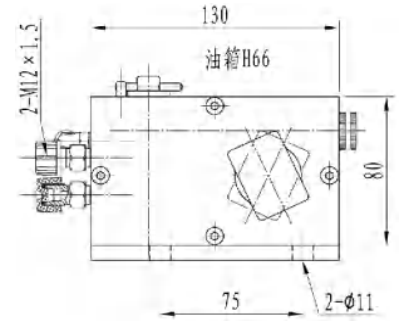
**SORL NO. 5003 316 312 0**

DESCRIPTION	FOR	OEM NO.
Cabin Tilting Pump 举升泵	IVECO 依维柯	

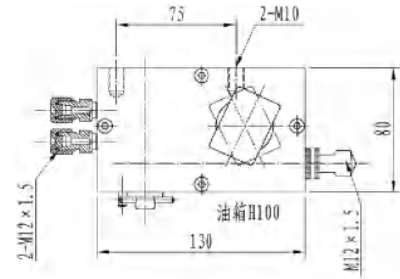
**SORL NO. 5003 316 313 0**

DESCRIPTION	FOR	OEM NO.
Cabin Tilting Pump 举升泵	IVECO 依维柯	1908460

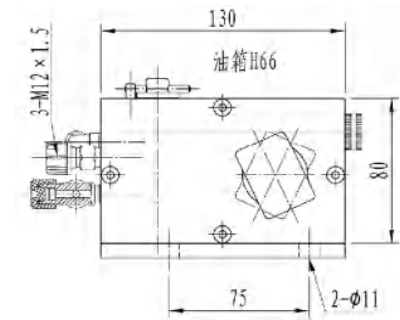
**SORL NO. 5003 316 314 0**

DESCRIPTION	FOR	OEM NO.
Cabin Tilting Pump 举升泵	IVECO 依维柯	41241683

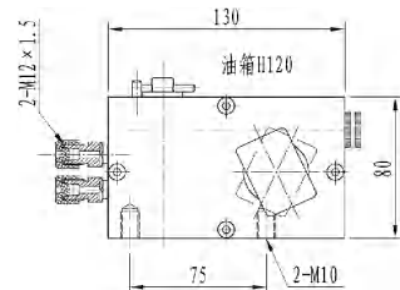
**SORL NO. 5004 C15 004 0**

DESCRIPTION	FOR	OEM NO.
Cabin Latch 液压锁	IVECO 依维柯	504125466

SERIES KAMAZ 卡玛斯系列



SORL NO. 5003 140 156 0

DESCRIPTION	FOR	OEM NO.
Cabin Tilting Cylinder 举升缸	KAMAZ 卡玛斯	181.5003010-01



SORL NO. 5003 140 157 0

DESCRIPTION	FOR	OEM NO.
Cabin Tilting Cylinder 举升缸	KAMAZ 卡玛斯	182.5004010 453198.237

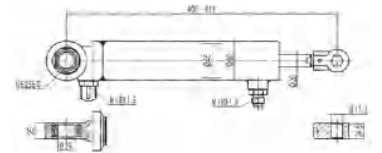

SORL NO. 5003 140 234 0

DESCRIPTION	FOR	OEM NO.
Cabin Tilting Cylinder 举升缸	KAMAZ 卡玛斯	6430-5003010

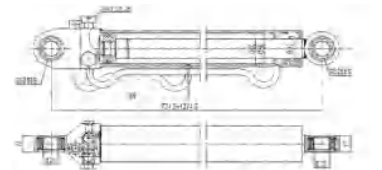

SORL NO. 5003 316 203 0

DESCRIPTION	FOR	OEM NO.
Cabin Tilting Pump 举升泵	KAMAZ 卡玛斯	6430-5004010

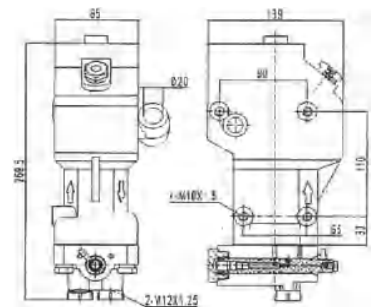

SORL NO. 5003 316 204 0

DESCRIPTION	FOR	OEM NO.
Cabin Tilting Pump 举升泵	KAMAZ 卡玛斯	5440-5004010

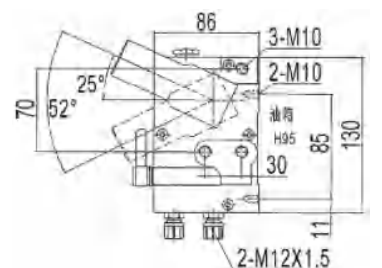

**SORL NO. 5003 316 205 0**

DESCRIPTION	FOR	OEM NO.
Cabin Tilting Pump 举升泵	KAMAZ 卡玛斯	458662.240

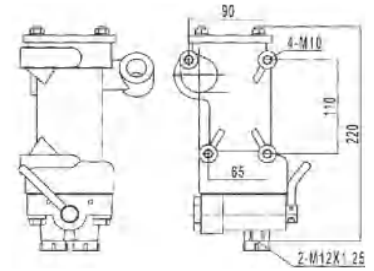
**SORL NO. 5003 316 206 0**

DESCRIPTION	FOR	OEM NO.
Cabin Tilting Pump 举升泵	KAMAZ 卡玛斯	4310-5004010

**SORL NO. 5003 316 207 0**

DESCRIPTION	FOR	OEM NO.
Cabin Tilting Pump 举升泵	KAMAZ 卡玛斯	45104-5004250

**SORL NO. 5003 316 207 0**

DESCRIPTION	FOR	OEM NO.
Cabin Tilting Pump 举升泵	KAMAZ 卡玛斯	182.5003010 458662.250

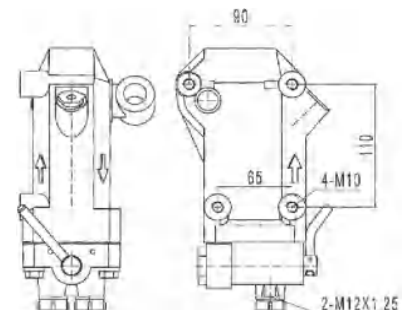

SERIES JAPANESE TRUCKS 日系系列

**SORL NO. 5003 140 209 0**

DESCRIPTION	FOR	OEM NO.
Cabin Tilting Cylinder 举升缸	HINO 日野	E13C 54960-E0360



SORL NO. 5003 140 210 0

DESCRIPTION	FOR	OEM NO.
Cabin Tilting Cylinder 举升缸	HINO 日野	K13C 52430-1220



SORL NO. 5003 140 211 0

DESCRIPTION	FOR	OEM NO.
Cabin Tilting Cylinder 举升缸	UD	CW520 95290-00Z09



SORL NO. 5003 140 212 0

DESCRIPTION	FOR	OEM NO.
Cabin Tilting Cylinder 举升缸	HINO 日野	EF750 52430-1090



SORL NO. 5003 140 239 0

DESCRIPTION	FOR	OEM NO.
Cabin Tilting Cylinder 举升缸	ISUZU 五十铃	

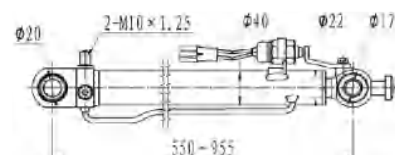

SORL NO. 5003 140 240 0

DESCRIPTION	FOR	OEM NO.
Cabin Tilting Cylinder 举升缸	ISUZU 五十铃	6WF1 1-53457139-1

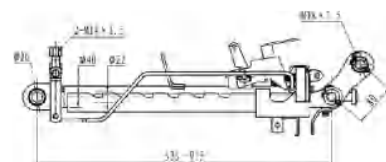

SORL NO. 5003 140 241 0

DESCRIPTION	FOR	OEM NO.
Cabin Tilting Cylinder 举升缸	MITSUBISHI 三菱	



SORL NO. 5003 140 242 0

DESCRIPTION	FOR	OEM NO.
Cabin Tilting Cylinder 举升缸	MITSUBISHI 三菱	



SORL NO. 5003 753 058 0

DESCRIPTION	FOR	OEM NO.
Electric Hydraulic Pump 电动泵	ISUZU 五十铃	10PE1 1-53457138-1

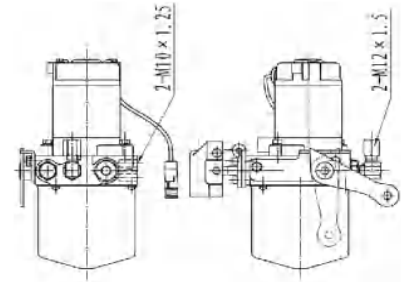

SORL NO. 5003 753 059 0

DESCRIPTION	FOR	OEM NO.
Electric Hydraulic Pump 电动泵	HINO 日野	EF750 52440-1700



SORL NO. 5003 753 060 0

DESCRIPTION	FOR	OEM NO.
Electric Hydraulic Pump 电动泵	HINO 日野	F20C/K13C 52440-2090



SORL NO. 5003 753 061 0

DESCRIPTION	FOR	OEM NO.
Electric Hydraulic Pump 电动泵	ISUZU 五十铃	CXZ187 1-53457



SORL NO. 5003 753 062 0

DESCRIPTION	FOR	OEM NO.
Electric Hydraulic Pump 电动泵	HINO 日野	P11C/FM2P 54870-E0030



SORL NO. 5003 753 063 0

DESCRIPTION	FOR	OEM NO.
Electric Hydraulic Pump 电动泵	mitsubishi 三菱	FV419/330 MC630432



SORL NO. 5003 753 064 0

DESCRIPTION	FOR	OEM NO.
Electric Hydraulic Pump 电动泵	mitsubishi 三菱	FV517 MC056548

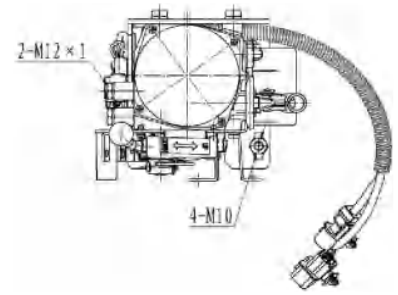

SORL NO. 5003 753 065 0

DESCRIPTION	FOR	OEM NO.
Electric Hydraulic Pump 电动泵	mitsubishi 三菱	6D22/FV415



SORL NO. 5003 753 066 0

DESCRIPTION	FOR	OEM NO.
Electric Hydraulic Pump 电动泵	ISUZU 五十铃	6WF1 1-53458965-0



SORL NO. 5003 753 067 0

DESCRIPTION	FOR	OEM NO.
Electric Hydraulic Pump 电动泵	UD 日产柴	CW520 95292-00Z04



SORL NO. 5003 753 070 0

DESCRIPTION	FOR	OEM NO.
Electric Hydraulic Pump 电动泵	UD 日产柴	



SORL NO. 5003 753 082 0

DESCRIPTION	FOR	OEM NO.
Electric Hydraulic Pump 电动泵	ISUZU 五十铃	



SORL NO. 5004 C15 001 0

DESCRIPTION	FOR	OEM NO.
Cabin Latch 液压锁	HINO (left) 日野(左)	



SORL NO. 5004 C15 002 0

DESCRIPTION	FOR	OEM NO.
Cabin Latch 液压锁	HINO (right) 日野(右)	

SERIES KOREAN TRUCKS 韩系系列



SORL NO. 5003 140 243 0

DESCRIPTION	FOR	OEM NO.
Cabin Tilting Cylinder 举升缸	KOREAN TRUCKS 韩系系列	

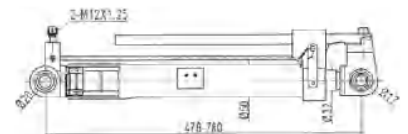

SORL NO. 5003 140 244 0

DESCRIPTION	FOR	OEM NO.
Cabin Tilting Cylinder 举升缸	KOREAN TRUCKS 韩系系列	





SORL NO. 5003 140 245 0

DESCRIPTION	FOR	OEM NO.
Cabin Tilting Cylinder 举升缸	KOREAN TRUCKS 韩系系列	



SORL NO. 5003 140 246 0

DESCRIPTION	FOR	OEM NO.
Cabin Tilting Cylinder 举升缸	KOREAN TRUCKS 韩系系列	

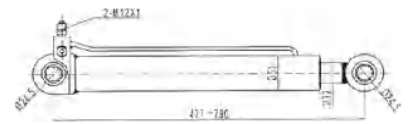

SORL NO. 5003 316 307 0

DESCRIPTION	FOR	OEM NO.
Cabin Tilting Pump 举升泵	KOREAN TRUCKS 韩系系列	

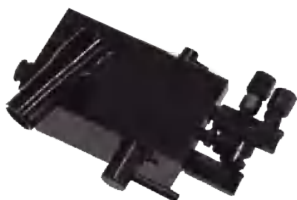
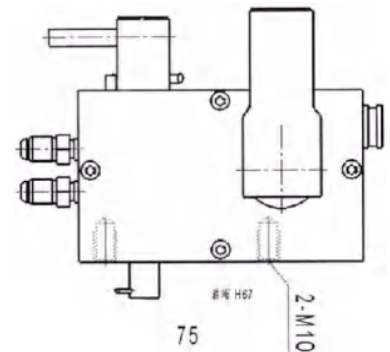

SORL NO. 5003 316 308 0

DESCRIPTION	FOR	OEM NO.
Cabin Tilting Pump 举升泵	KOREAN TRUCKS 韩系系列	

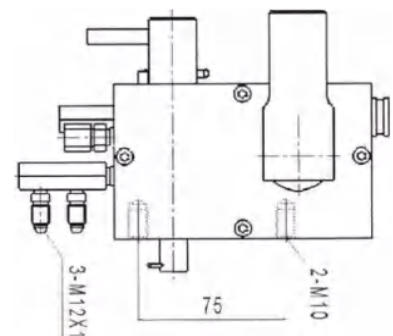

SORL NO. 5003 316 309 0

DESCRIPTION	FOR	OEM NO.
Cabin Tilting Pump 举升泵	KOREAN TRUCKS 韩系系列	

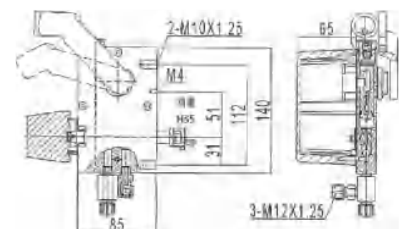

SERIES AMERICAN INTERNATIONAL 美系系列



SORL NO. 5003 150 051 0

DESCRIPTION	FOR	OEM NO.
Cabin Tilting Cylinder 举升缸	AMERICA INTERNATIONAL 美系系列	CA20187307 18-37233-000

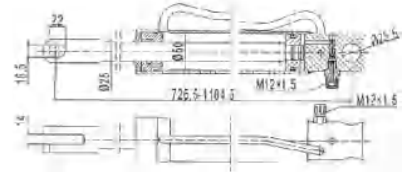

SORL NO. 5003 150 052 0

DESCRIPTION	FOR	OEM NO.
Cabin Tilting Cylinder 举升缸	AMERICA INTERNATIONAL 美系系列	CA20187307 18-37233-000

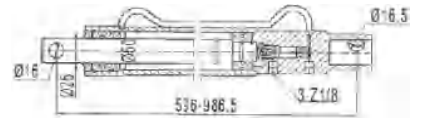

SORL NO. 5003 140 247 0

DESCRIPTION	FOR	OEM NO.
Cabin Tilting Cylinder 举升缸	AMERICA INTERNATIONAL 美系系列	CD15157502 1672204C91 14420129

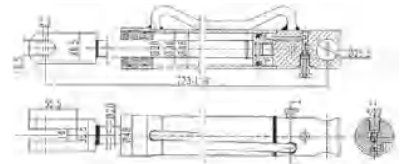

SORL NO. 5003 316 310 0

DESCRIPTION	FOR	OEM NO.
Cabin Tilting Pump 举升泵	AMERICA INTERNATIONAL 美系系列	

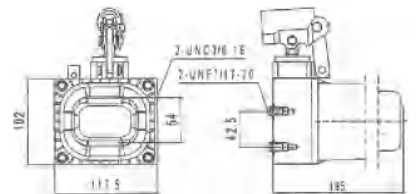

SORL NO. 5003 316 311 0

DESCRIPTION	FOR	OEM NO.
Cabin Tilting Pump 举升泵	AMERICA INTERNATIONAL 美系系列	

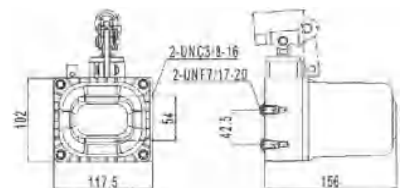

SERIES SINOTRUK 重汽系列



SORL NO. 5003 135 001 0

DESCRIPTION	FOR	OEM NO.
Cabin Cylinder 举升缸	Light(main) 重汽轻卡(主缸)	LG9716827010

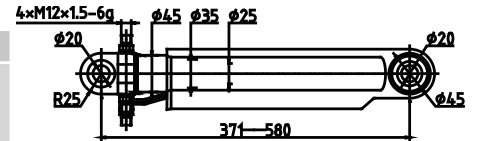

SORL NO. 5003 135 002 0

DESCRIPTION	FOR	OEM NO.
Cabin Cylinder 举升缸	Light(slave) 重汽轻卡(副缸)	LG9716827011

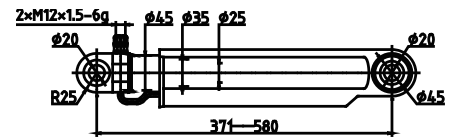

SORL NO. 5003 140 004 0

DESCRIPTION	FOR	OEM NO.
Cabin Cylinder 举升缸	STYER 斯太尔	WG9100820028

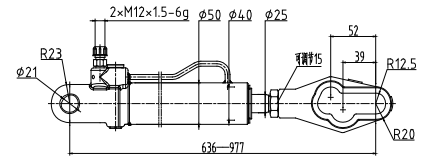

SORL NO. 5003 140 006 0

DESCRIPTION	FOR	OEM NO.
Cabin Cylinder 举升缸	HANIA 豪运	NZ9525820113

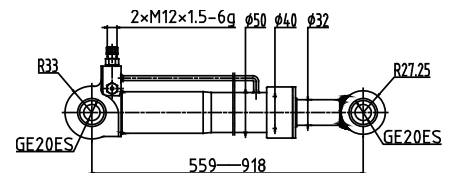

SORL NO. 5003 140 007 0

DESCRIPTION	FOR	OEM NO.
Cabin Cylinder 举升缸	KING PRINCE 09 金王子09款	AZ9123820007

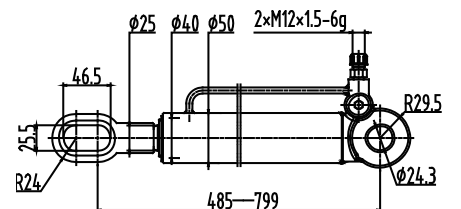



SORL NO. 5003 140 045 0

DESCRIPTION	FOR	OEM NO.
Cabin Cylinder 举升缸	STYER(short) 斯太尔(短缸)	

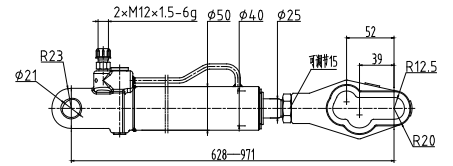

SORL NO. 5003 140 046 0

DESCRIPTION	FOR	OEM NO.
Cabin Cylinder 举升缸	STYER(long) 斯太尔(长缸)	

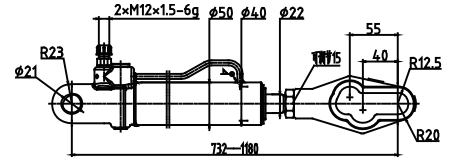

SORL NO. 5003 140 079 0

DESCRIPTION	FOR	OEM NO.
Cabin Cylinder 举升缸	HANIA(main) 豪运老款(主缸)	NZ9525820112

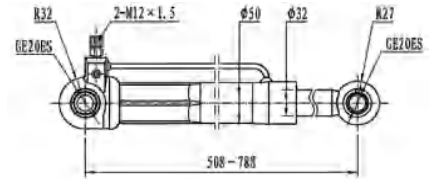

SORL NO. 5003 140 080 0

DESCRIPTION	FOR	OEM NO.
Cabin Cylinder 举升缸	HANIA(slave) 豪运老款(副缸)	NZ9525820110

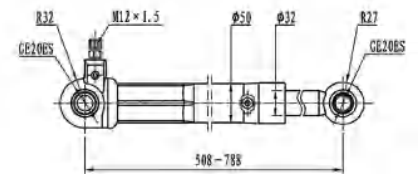

SORL NO. 5003 140 081 0

DESCRIPTION	FOR	OEM NO.
Cabin Cylinder 举升缸	Light 重汽海西	5004205069

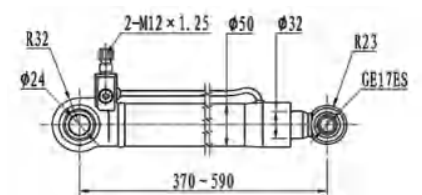

SORL NO. 5003 140 082 0

DESCRIPTION	FOR	OEM NO.
Cabin Cylinder 举升缸	Light 重汽海西	5004203069

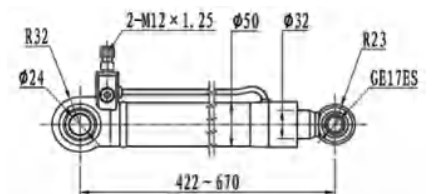



SORL NO. 5003 140 083 0

DESCRIPTION	FOR	OEM NO.
Cabin Cylinder 举升缸	KING 重汽王牌	

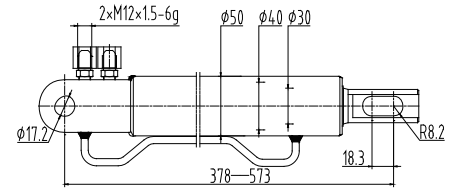

SORL NO. 5003 140 084 0

DESCRIPTION	FOR	OEM NO.
Cabin Cylinder 举升缸	HOHAN 豪瀚	WG9525820020

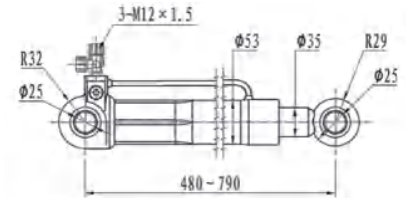

SORL NO. 5003 140 085 0

DESCRIPTION	FOR	OEM NO.
Cabin Cylinder 举升缸	SINOTRUK T5G 重汽T5G	812W41723-6125

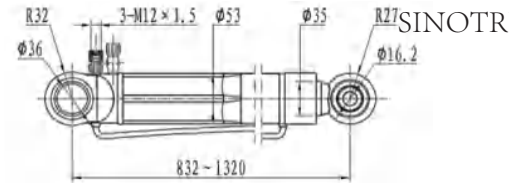

SORL NO. 5003 140 086 0

DESCRIPTION	FOR	OEM NO.
Cabin Cylinder 举升缸	STYER(main) 斯太尔(主缸)	WG9312820042

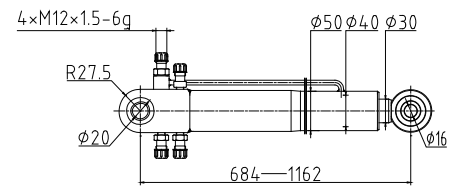

SORL NO. 5003 140 087 0

DESCRIPTION	FOR	OEM NO.
Cabin Cylinder 举升缸	STYER(slave) 斯太尔(副缸)	WG9312820043

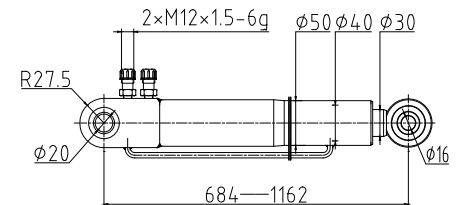

SORL NO. 5003 140 088 0

DESCRIPTION	FOR	OEM NO.
Cabin Cylinder 举升缸	C7 重汽C7	811W41723-6020

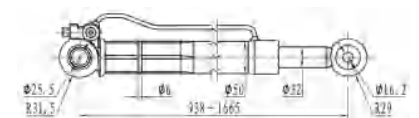



SORL NO. 5003 140 089 0

DESCRIPTION	FOR	OEM NO.
Cabin Cylinder 举升缸	NEW HUANGHE 新黄河	WG9125820045



SORL NO. 5003 140 094 0

DESCRIPTION	FOR	OEM NO.
Cabin Cylinder 举升缸	NEW STYER 新斯太尔	WG9312820013

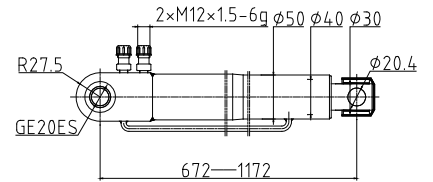

SORL NO. 5003 140 150 0

DESCRIPTION	FOR	OEM NO.
Cabin Cylinder 举升缸	KING 重汽王牌	

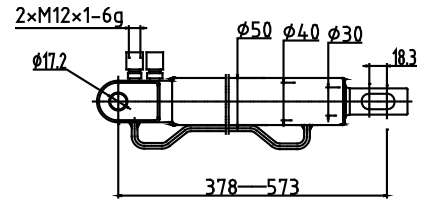

SORL NO. 5003 145 002 0

DESCRIPTION	FOR	OEM NO.
Cabin Cylinder 举升缸	SINOTRUK T5G 重汽T5G	812W41723-6125

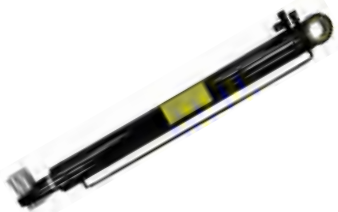
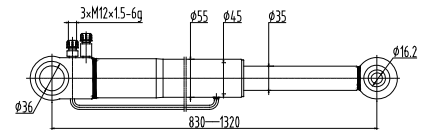

SORL NO. 5003 150 002 0

DESCRIPTION	FOR	OEM NO.
Cabin Cylinder 举升缸	HOWO A7 豪沃A7	WG9925824014

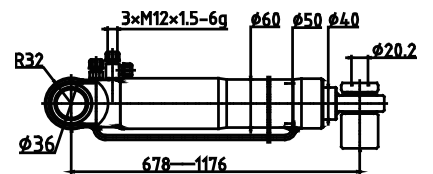

SORL NO. 5003 150 004 0

DESCRIPTION	FOR	OEM NO.
Cabin Cylinder 举升缸	HOWO 豪沃	WG9719820002

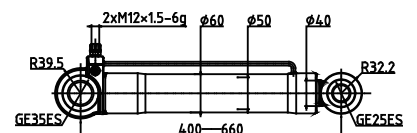



SORL NO. 5003 150 005 0

DESCRIPTION	FOR	OEM NO.
Cabin Cylinder 举升缸	KING PRINCE 10 金王子10款	AZ9125820014

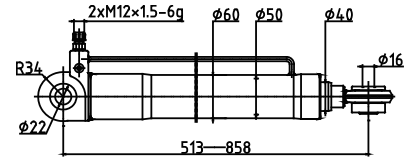

SORL NO. 5003 150 014 0

DESCRIPTION	FOR	OEM NO.
Cabin Cylinder 举升缸	HOWO A7(short) 豪沃A7(短缸)	WG9925823014

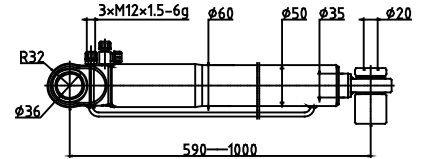

SORL NO. 5003 150 030 0

DESCRIPTION	FOR	OEM NO.
Cabin Cylinder 举升缸	NEW HOWO 新款豪沃	WG9719820004

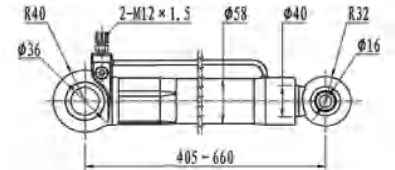

SORL NO. 5003 150 031 0

DESCRIPTION	FOR	OEM NO.
Cabin Cylinder 举升缸	HOWO A7 豪沃A7	WG9925820004

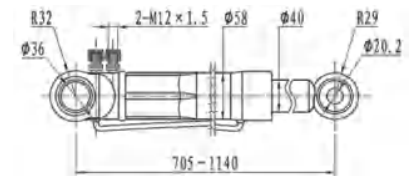

SORL NO. 5003 150 032 0

DESCRIPTION	FOR	OEM NO.
Cabin Cylinder 举升缸	PORT CARRIER 重汽码头车	TZ53718200040

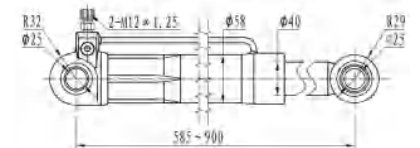

SORL NO. 5003 316 004 0

DESCRIPTION	FOR	OEM NO.
Hydraulic Cabin Pump 举升泵	HOWO 豪沃	WG9719820001

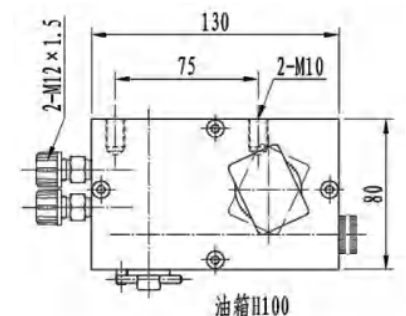



SORL NO. 5003 316 009 0

DESCRIPTION	FOR	OEM NO.
Hydraulic Cabin Pump 举升泵	STYER 斯太尔/德龙/奥龙/红岩金刚(小)	WG9710820025

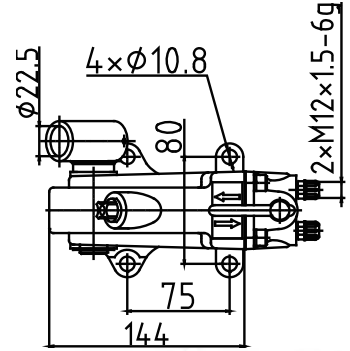

SORL NO. 5003 316 010 0

DESCRIPTION	FOR	OEM NO.
Hydraulic Cabin Pump 举升泵	HOWO A7 豪沃A7	WG9925823002

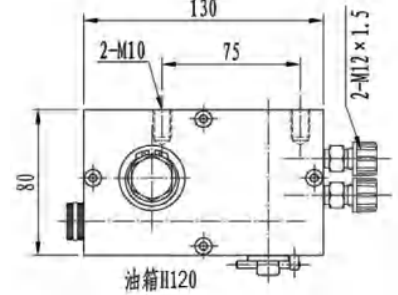

SORL NO. 5003 316 011 0

DESCRIPTION	FOR	OEM NO.
Hydraulic Cabin Pump 举升泵	HANIA 豪运	NZ9525820017

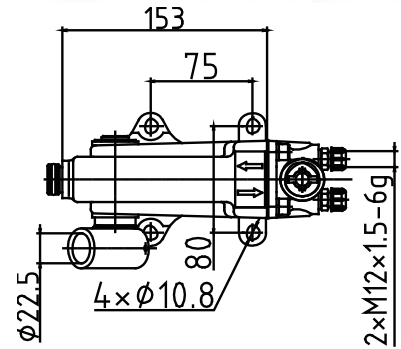

SORL NO. 5003 316 072 0

DESCRIPTION	FOR	OEM NO.
Hydraulic Cabin Pump 举升泵	HOWO (reverse) 豪沃(反方向)	

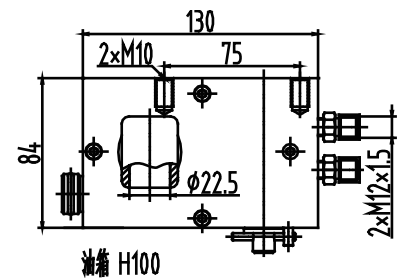

SORL NO. 5003 316 076 0

DESCRIPTION	FOR	OEM NO.
Hydraulic Cabin Pump 举升泵	HOWO A7 (4-hole hexagon) 豪沃A7(四孔六角)	WG9925822002

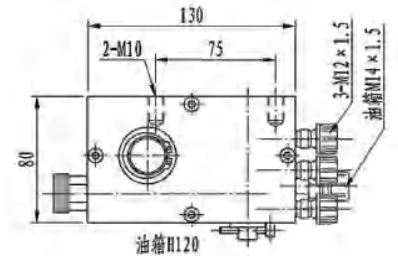

SORL NO. 5003 316 107 0

DESCRIPTION	FOR	OEM NO.
Hydraulic Cabin Pump 举升泵	HOHAN(4-hole) 豪瀚(四孔)	AZ9525820019

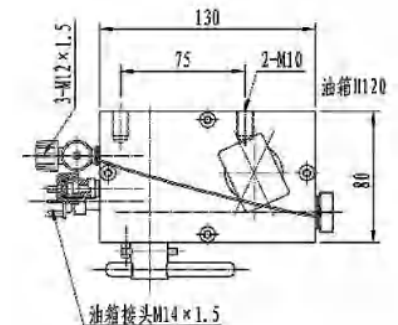



SORL NO. 5003 316 115 0

DESCRIPTION	FOR	OEM NO.
Hydraulic Cabin Pump 举升泵	SINOTRUK(2-hole) 重汽(二孔)	WG9925823012

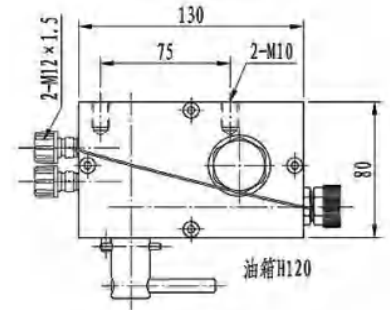

SORL NO. 5003 316 122 0

DESCRIPTION	FOR	OEM NO.
Hydraulic Cabin Pump 举升泵	HANIA(NEW) 豪运(新款)	NZ9525820017

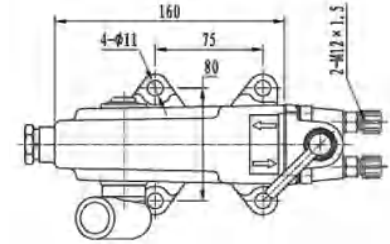

SORL NO. 5003 316 123 0

DESCRIPTION	FOR	OEM NO.
Hydraulic Cabin Pump 举升泵	Light 重汽海西	5000501069 5000504069

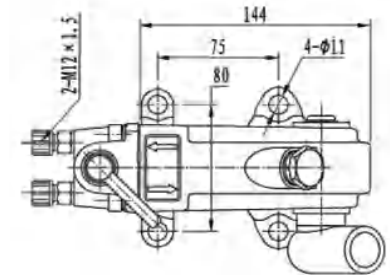

SORL NO. 5003 316 124 0

DESCRIPTION	FOR	OEM NO.
Hydraulic Cabin Pump 举升泵	KING 重汽王牌	

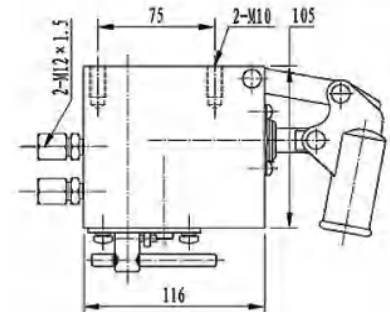

SORL NO. 5003 316 125 0

DESCRIPTION	FOR	OEM NO.
Hydraulic Cabin Pump 举升泵	HOHAN(3-hole) 豪瀚(三孔)	AZ9525820010

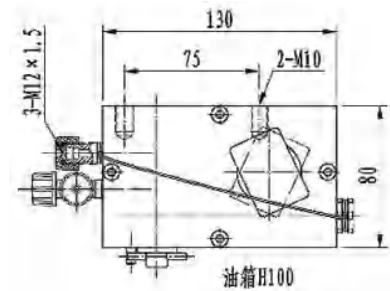

SORL NO. 5003 316 126 0

DESCRIPTION	FOR	OEM NO.
Hydraulic Cabin Pump 举升泵	SINOTRUK(4-hole) 重汽(四孔)	WG9925823022

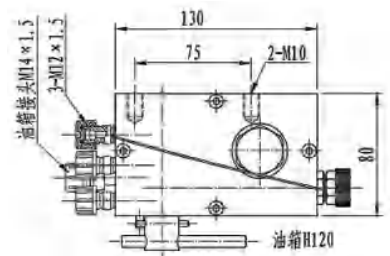



SORL NO. 5003 316 127 0

DESCRIPTION	FOR	OEM NO.
Hydraulic Cabin Pump 举升泵	STYER(bigger oil box) 斯太尔(加大油箱)	

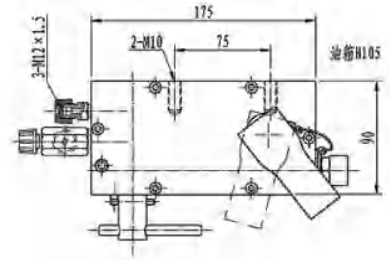

SORL NO. 5003 316 128 0

DESCRIPTION	FOR	OEM NO.
Hydraulic Cabin Pump 举升泵	STYER(5-hole) 斯太尔(五孔)	WG9312820046

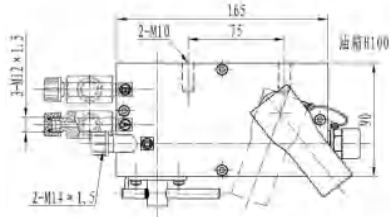

SORL NO. 5003 316 129 0

DESCRIPTION	FOR	OEM NO.
Hydraulic Cabin Pump 举升泵	HANIA(bigger) 豪运(加大扁泵)	NZ9525820018

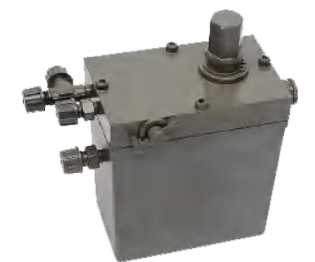
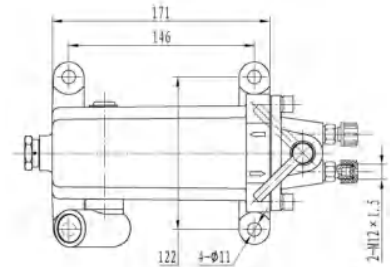

SORL NO. 5003 316 130 0

DESCRIPTION	FOR	OEM NO.
Hydraulic Cabin Pump 举升泵	HOWO A7(4-hole hexagon) 豪沃A7(四孔六角)	WG9925824002

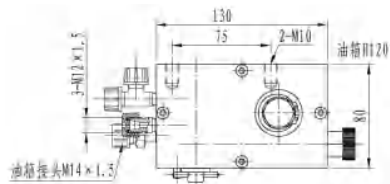

SORL NO. 5003 316 131 0

DESCRIPTION	FOR	OEM NO.
Hydraulic Cabin Pump 举升泵	HOWO(LH) 豪沃(左置)	WG19826001

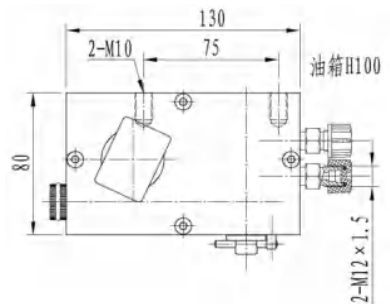

SORL NO. 5003 316 132 0

DESCRIPTION	FOR	OEM NO.
Hydraulic Cabin Pump 举升泵	SINOTRUK C7(RH) 重汽C7(左置)	811W41723-6004

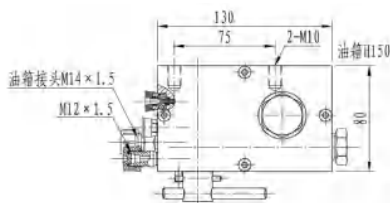



SORL NO. 5003 316 133 0

DESCRIPTION	FOR	OEM NO.
Hydraulic Cabin Pump 举升泵	SINOTRUK C7(LH) 重汽C7(右置)	811W41723-6008

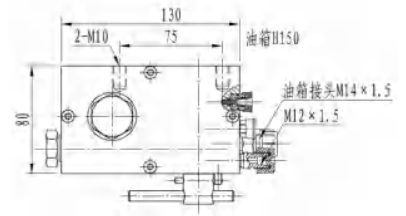

SORL NO. 5003 316 193 0

DESCRIPTION	FOR	OEM NO.
Hydraulic Cabin Pump 举升泵	HOWO A7 豪沃A7	WG9925821002

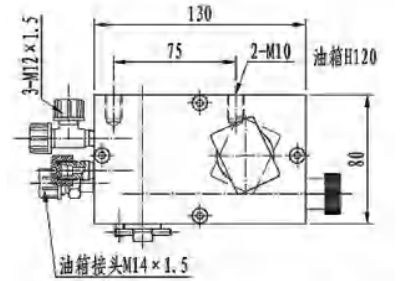

SORL NO. 5003 316 200 0

DESCRIPTION	FOR	OEM NO.
Hydraulic Cabin Pump 举升泵	Light 重汽轻卡	LG9716827020

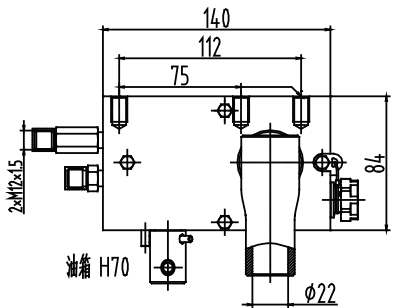

SORL NO. 5003 316 201 0

DESCRIPTION	FOR	OEM NO.
Hydraulic Cabin Pump 举升泵	Light 重汽轻卡 (带电动泵车型)	LG9716827021

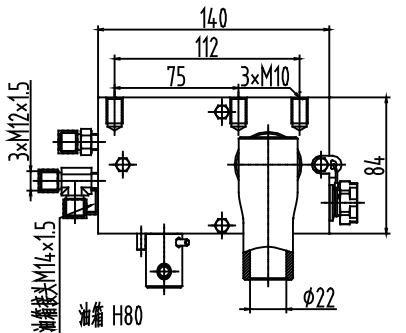

SORL NO. 5003 753 006 0

DESCRIPTION	FOR	OEM NO.
Electric Hydraulic Pump 电动泵	HOWO A7 豪沃A7	WG9925820031

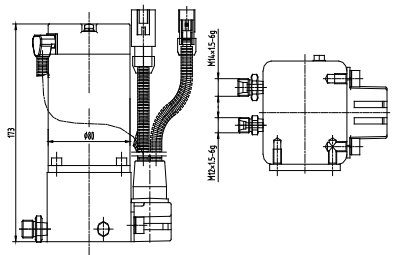

SORL NO. 5003 753 015 0

DESCRIPTION	FOR	OEM NO.
Electric Hydraulic Pump 电动泵	HOWO A7 豪沃A7	WG9925821031

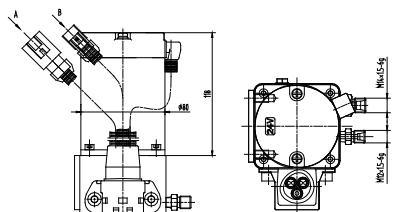

SORL NO. 5003 753 038 0

DESCRIPTION	FOR	OEM NO.
Electric Hydraulic Pump 电动泵	Light 重汽轻卡	LG9716827060/A

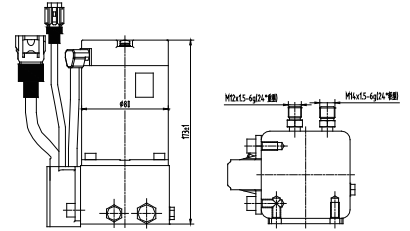

SORL NO. 5003 753 068 0

DESCRIPTION	FOR	OEM NO.
Electric Hydraulic Pump 电动泵	STYER 斯太尔	WG9312820022

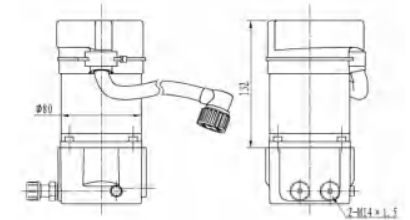

SORL NO. 5003 753 069 0

DESCRIPTION	FOR	OEM NO.
Electric Hydraulic Pump 电动泵	HOWO A7(NEW) 豪沃A7(新款)	WG9925820031

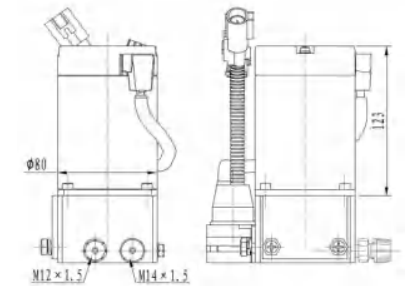

SORL NO. 5004 C3 001 0

DESCRIPTION	FOR	OEM NO.
Cabin Latch 液压锁	STYER 斯太尔	WG1600441008



SORL NO. 5004 C3 002 0

DESCRIPTION	FOR	OEM NO.
Cabin Latch 液压锁	HOWO 豪沃	WG1642440101



SORL NO. 5004 C3 003 0

DESCRIPTION	FOR	OEM NO.
Cabin Latch 液压锁	KING PRINCE 金王子	WG1608440009





SORL NO. 5004 C3 004 0

DESCRIPTION	FOR	OEM NO.
Cabin Latch 液压锁	KING PRINCE 金王子	WG1608444010



SORL NO. 5004 C3 005 0

DESCRIPTION	FOR	OEM NO.
Cabin Latch 液压锁	HOWO A7 豪沃A7	WG1664440101



SORL NO. 5004 C3 006 0

DESCRIPTION	FOR	OEM NO.
Cabin Latch 液压锁	HOWO T5G 豪沃T5G	810W61851-6030



SORL NO. 3409 050 007 0

DESCRIPTION	FOR	OEM NO.
Power Cylinder 转向助力缸	STYER 斯太尔	WG9014470008

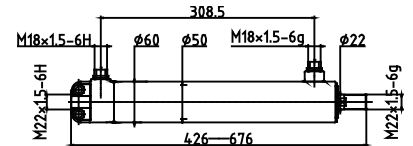

SORL NO. 3409 050 009 0

DESCRIPTION	FOR	OEM NO.
Power Cylinder 转向助力缸	HOWO 豪沃	WG9131470250

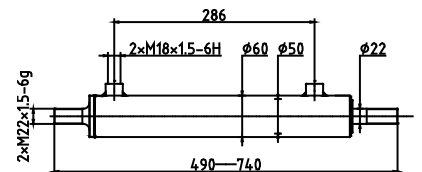

SORL NO. 3409 070 001 0

DESCRIPTION	FOR	OEM NO.
Power Cylinder 转向助力缸	HOWO 豪沃	WG9731470070

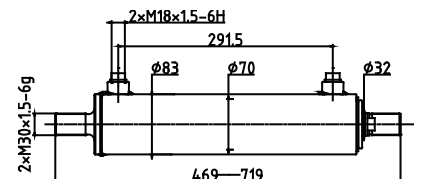



SORL NO. 3409 070 002 0

DESCRIPTION	FOR	OEM NO.
Power Cylinder 转向助力缸	HOWO 70Harvesters 豪沃70矿车	WG9770470070

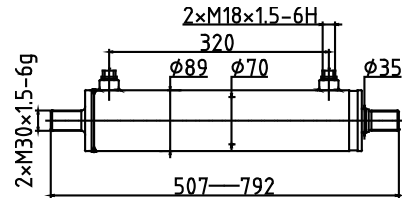

SORL NO. 3409 150 007 0

DESCRIPTION	FOR	OEM NO.
Power Cylinder 转向助力缸	STYER (with rod joint assembly) 斯太尔(带助力缸球头)	WG9014470008

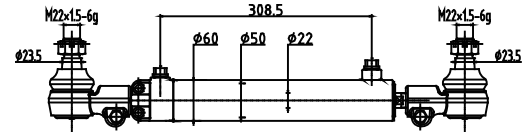

SORL NO. 3409 170 001 0

DESCRIPTION	FOR	OEM NO.
Power Cylinder 转向助力缸	HOWO (with rod joint assembly) 豪沃(带助力缸球头)	WG9731470070

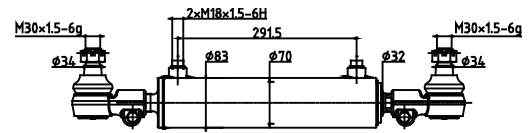

SORL NO. 3409 170 002 0

DESCRIPTION	FOR	OEM NO.
Power Cylinder 转向助力缸	HOWO 70Harvesters (with rod joint assembly) 豪沃70矿车(带助力缸球头)	WG9770470070

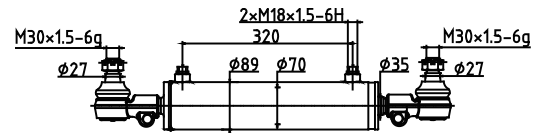

SERIES FAW JIEFANG 一汽系列



SORL NO. 5003 136 001 0

DESCRIPTION	FOR	OEM NO.
Cabin Cylinder 举升缸	XINDA V D816 新大威D816	5001120-D816

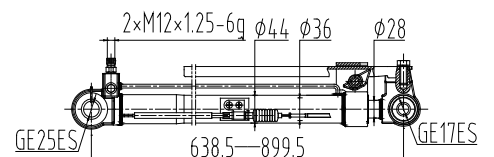



SORL NO. 5003 136 002 0

DESCRIPTION	FOR	OEM NO.
Cabin Cylinder 举升缸	XINDA V Q458 新大威Q458	5001120-Q458

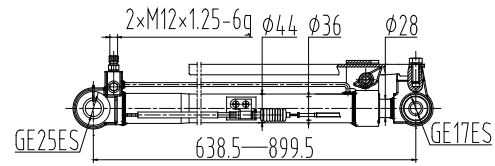

SORL NO. 5003 136 003 0

DESCRIPTION	FOR	OEM NO.
Cabin Cylinder 举升缸	XINDA V Q491 新大威Q491	5001120-Q491

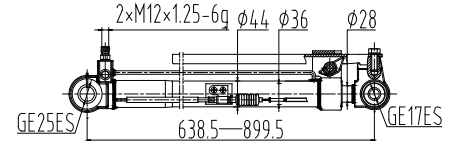

SORL NO. 5003 136 005 0

DESCRIPTION	FOR	OEM NO.
Cabin Cylinder 举升缸	QINGDAO 青汽前四后八	5001110-Q148T

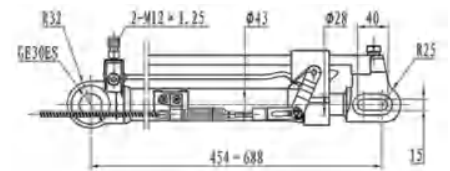

SORL NO. 5003 136 010 0

DESCRIPTION	FOR	OEM NO.
Cabin Cylinder 举升缸	XINDA V D906 新大威D906	5001120-D906

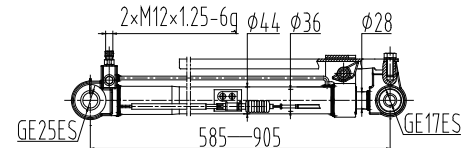

SORL NO. 5003 136 012 0

DESCRIPTION	FOR	OEM NO.
Cabin Cylinder 举升缸	HAN V D453E 悍威D453E	5001120-D453E

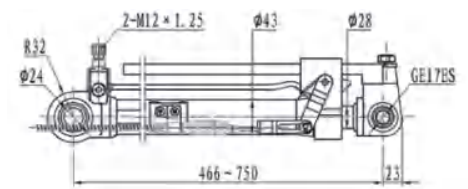

SORL NO. 5003 136 013 0

DESCRIPTION	FOR	OEM NO.
Cabin Cylinder 举升缸	HAN V 770 悍威770	5001120-770

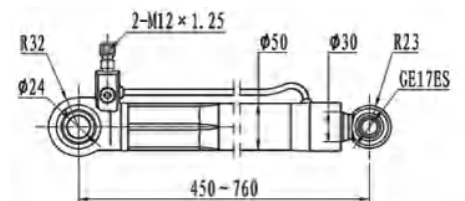



SORL NO. 5003 136 014 0

DESCRIPTION	FOR	OEM NO.
Cabin Cylinder 举升缸	XINDA V D911 新大威D911	5001120-D911

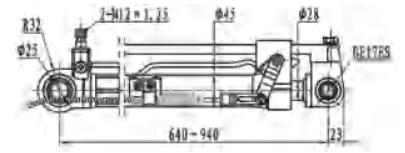

SORL NO. 5003 136 015 0

DESCRIPTION	FOR	OEM NO.
Cabin Cylinder 举升缸	FAW Q802 解放Q802	5001120-Q802

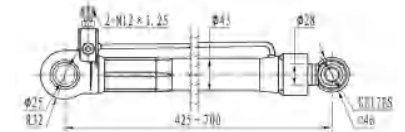

SORL NO. 5003 136 024 0

DESCRIPTION	FOR	OEM NO.
Cabin Cylinder 举升缸	XINDA V Q204 新大威Q204	5001120-Q204

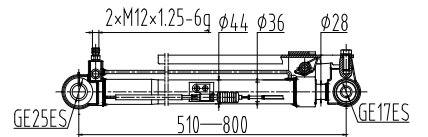

SORL NO. 5003 136 025 0

DESCRIPTION	FOR	OEM NO.
Cabin Cylinder 举升缸	AO V 371 奥威371	5001120-371

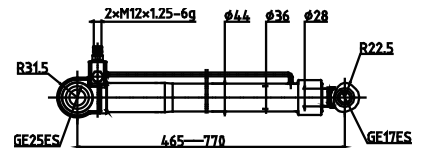

SORL NO. 5003 136 028 0

DESCRIPTION	FOR	OEM NO.
Cabin Cylinder 举升缸	奥威242	5001120B242

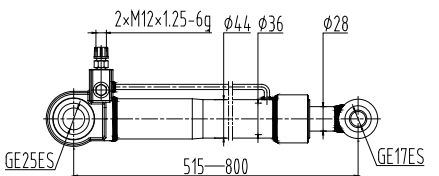

SORL NO. 5003 140 003 0

DESCRIPTION	FOR	OEM NO.
Cabin Cylinder 举升缸	XINDA V D840 新大威D840	5001120-D840

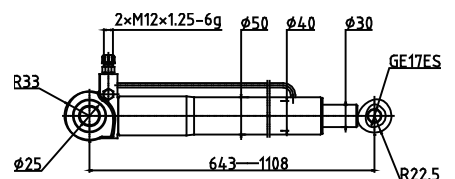



SORL NO. 5003 140 005 0

DESCRIPTION	FOR	OEM NO.
Cabin Cylinder 举升缸	HAN V D362 悍威D362	5001120-362

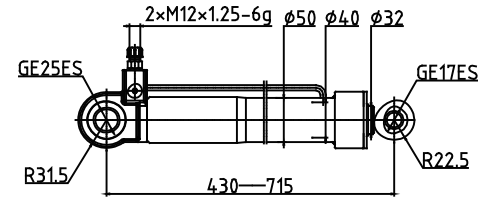

SORL NO. 5003 140 008 0

DESCRIPTION	FOR	OEM NO.
Cabin Cylinder 举升缸	AO V 242 奥威242	5001120B242

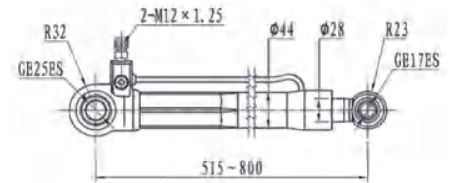

SORL NO. 5003 140 011 0

DESCRIPTION	FOR	OEM NO.
Cabin Cylinder 举升缸	AO V 739B 奥威739B	5001120-739B

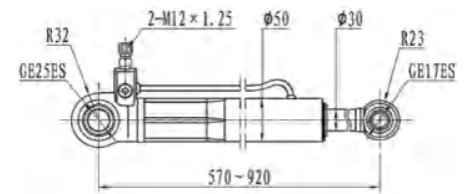

SORL NO. 5003 140 012 0

DESCRIPTION	FOR	OEM NO.
Cabin Cylinder 举升缸	HAN V D488 悍威D488	5001120-D488 5001901-D488

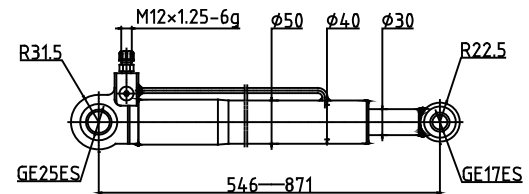

SORL NO. 5003 140 013 0

DESCRIPTION	FOR	OEM NO.
Cabin Cylinder 举升缸	HAN V D453F 悍威D453F	5001120-D453F

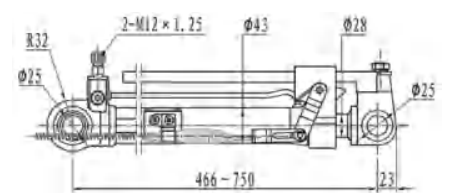

SORL NO. 5003 140 061 0

DESCRIPTION	FOR	OEM NO.
Cabin Cylinder 举升缸	FAW D485 解放D485	5001120-D485

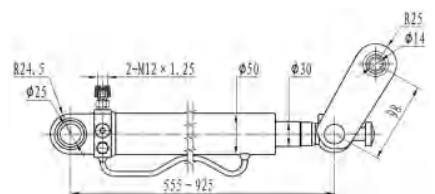



SORL NO. 5003 140 098 0

DESCRIPTION	FOR	OEM NO.
Cabin Cylinder 举升缸	FAW TIAN V 解放天威	5001120-D979E

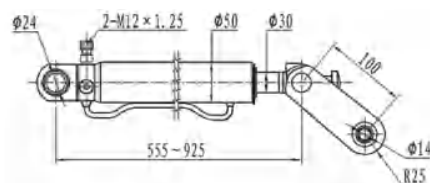

SORL NO. 5003 140 099 0

DESCRIPTION	FOR	OEM NO.
Cabin Cylinder 举升缸	FAW J6 解放J6	5002015-B35J

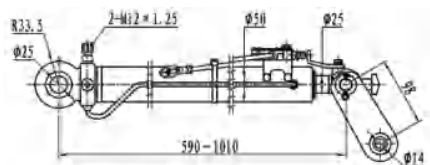

SORL NO. 5003 140 100 0

DESCRIPTION	FOR	OEM NO.
Cabin Cylinder 举升缸	JIANGHUAN 江环	

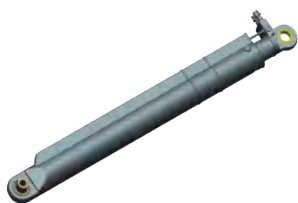
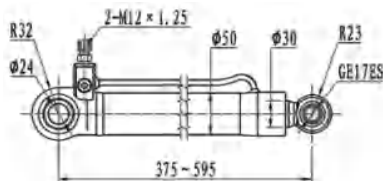

SORL NO. 5003 140 101 0

DESCRIPTION	FOR	OEM NO.
Cabin Cylinder 举升缸	J6 NAVIGATOR 领航版J6	5002020AB85-C00

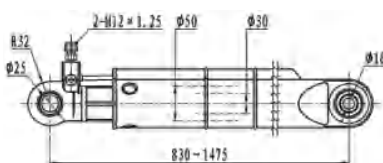

SORL NO. 5003 140 102 0

DESCRIPTION	FOR	OEM NO.
Cabin Cylinder 举升缸	FAW JH6 NAVIGATOR (long) 解放JH6(领航加长版)	5002020-1063-C00

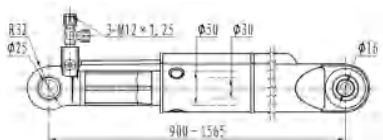

SORL NO. 5003 140 103 0

DESCRIPTION	FOR	OEM NO.
Cabin Cylinder 举升缸	FAW TU V 解放途V	5001120-D9806

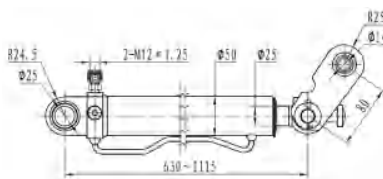



SORL NO. 5003 140 104 0

DESCRIPTION	FOR	OEM NO.
Cabin Cylinder 举升缸	FAW J7 解放J7	5002020-2000-C00

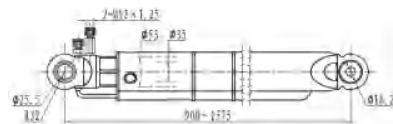

SORL NO. 5003 140 105 0

DESCRIPTION	FOR	OEM NO.
Cabin Cylinder 举升缸	FAW LONG V 解放龙威	5001120-DV001

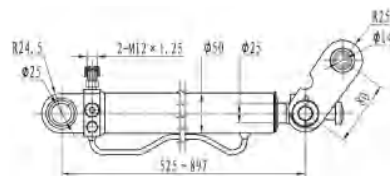

SORL NO. 5003 140 106 0

DESCRIPTION	FOR	OEM NO.
Cabin Cylinder 举升缸	FAW 解放	5001120-DH002

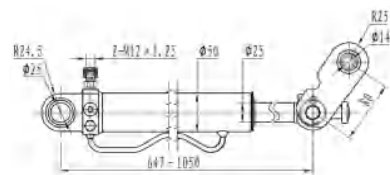

SORL NO. 5003 140 107 0

DESCRIPTION	FOR	OEM NO.
Cabin Cylinder 举升缸	FAW B91W 解放B91W	5002020-B91W

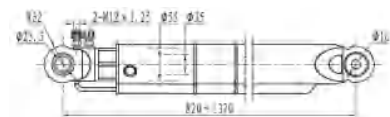

SORL NO. 5003 140 108 0

DESCRIPTION	FOR	OEM NO.
Cabin Cylinder 举升缸	FAW D595 解放D595	5001120-D595

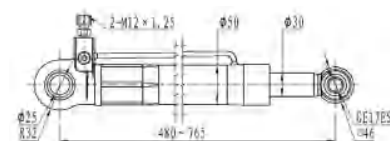

SORL NO. 5003 140 109 0

DESCRIPTION	FOR	OEM NO.
Cabin Cylinder 举升缸	FAW 50KZ 解放50KZ	50KZ-08010

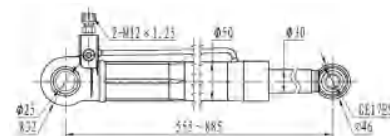



SORL NO. 5003 145 004 0

DESCRIPTION	FOR	OEM NO.
Cabin Cylinder 举升缸	FAW J7 解放J7	5002020-2000-C00

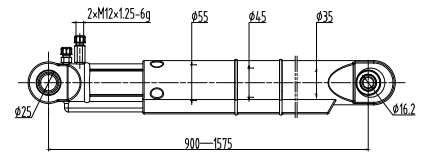

SORL NO. 5003 150 006 0

DESCRIPTION	FOR	OEM NO.
Cabin Cylinder 举升缸	FAW J6 解放J6	5002015-A09

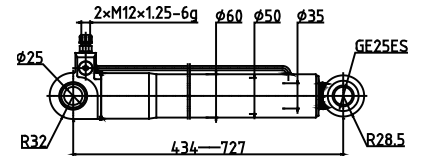

SORL NO. 5003 150 007 0

DESCRIPTION	FOR	OEM NO.
Cabin Cylinder 举升缸	FAW J6 解放J6	5002015-A01

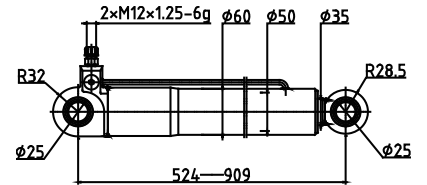

SORL NO. 5003 150 016 0

DESCRIPTION	FOR	OEM NO.
Cabin Cylinder 举升缸	FAW J6 解放J6	5002015BA09-C00

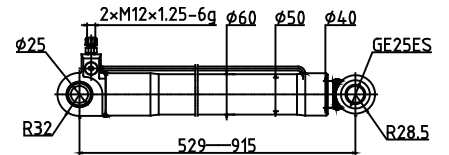

SORL NO. 5003 150 017 0

DESCRIPTION	FOR	OEM NO.
Cabin Cylinder 举升缸	FAW J6 解放J6	5002015-A91

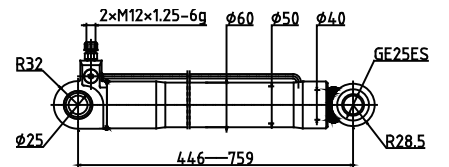

SORL NO. 5003 150 020 0

DESCRIPTION	FOR	OEM NO.
Cabin Cylinder 举升缸	FAW J6 解放J6	5002015-B40-C00

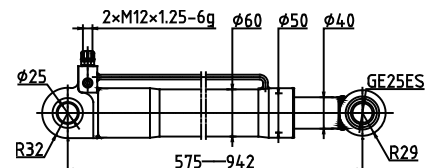



SORL NO. 5003 150 035 0

DESCRIPTION	FOR	OEM NO.
Cabin Cylinder 举升缸	FAW J6 解放J6	5002015-B33-C00

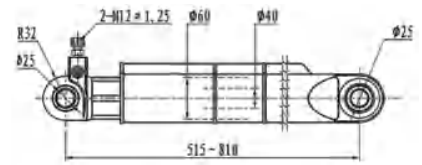

SORL NO. 5003 150 036 0

DESCRIPTION	FOR	OEM NO.
Cabin Cylinder 举升缸	FAW J6 解放J6	5002015-B44-C00

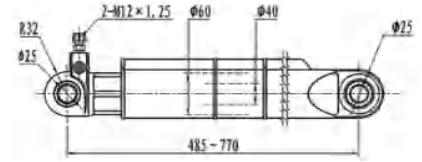

SORL NO. 5003 150 037 0

DESCRIPTION	FOR	OEM NO.
Cabin Cylinder 举升缸	FAW 解放	5002015-14B-C00

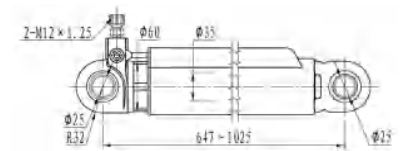

SORL NO. 5003 316 002 0

DESCRIPTION	FOR	OEM NO.
Hydraulic Cabin Pump 举升泵	AO V (2-hole) 奥威(二孔)	5001170A362

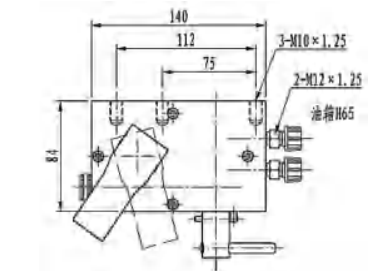

SORL NO. 5003 316 003 0

DESCRIPTION	FOR	OEM NO.
Hydraulic Cabin Pump 举升泵	FAW (3-hole with lock) 前四后八(三孔带拉锁)	

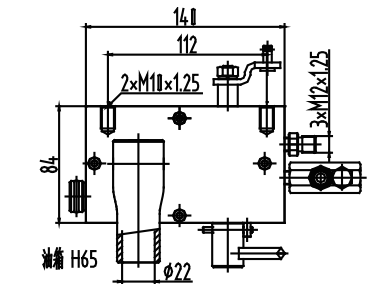

SORL NO. 5003 316 006 0

DESCRIPTION	FOR	OEM NO.
Hydraulic Cabin Pump 举升泵	AO V (3-hole) 奥威(三孔)	

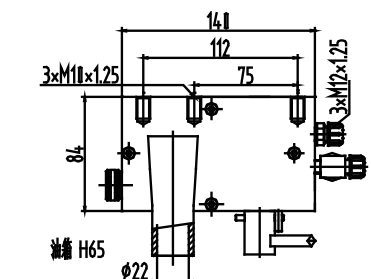



SORL NO. 5003 316 008 0

DESCRIPTION	FOR	OEM NO.
Hydraulic Cabin Pump 举升泵	J6 (3-hole) J6 (三孔)	5002070-29A

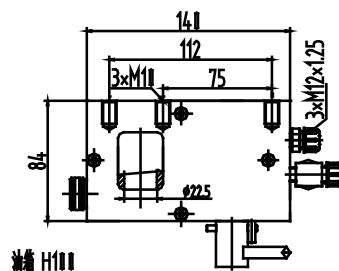

SORL NO. 5003 316 012 0

DESCRIPTION	FOR	OEM NO.
Hydraulic Cabin Pump 举升泵	J6 (5-hole) J6 (五孔)	5002070AA01-C02

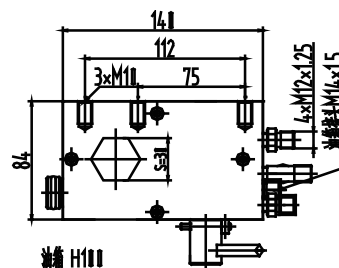

SORL NO. 5003 316 014 0

DESCRIPTION	FOR	OEM NO.
Hydraulic Cabin Pump 举升泵	AO V (4-hole) 奥威 (四孔)	

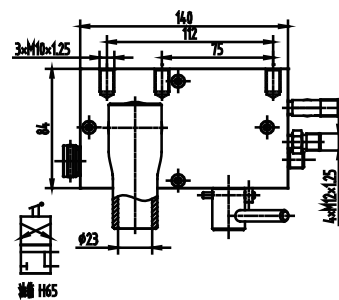

SORL NO. 5003 316 015 0

DESCRIPTION	FOR	OEM NO.
Hydraulic Cabin Pump 举升泵	HAN V 悍威	5001170A362

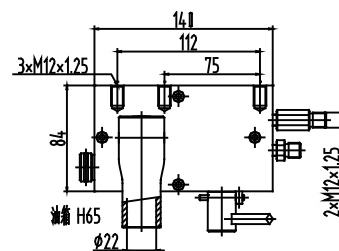

SORL NO. 5003 316 016 0

DESCRIPTION	FOR	OEM NO.
Hydraulic Cabin Pump 举升泵	XINDA V 新大威	

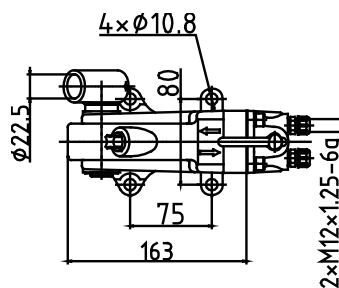

SORL NO. 5003 316 017 0

DESCRIPTION	FOR	OEM NO.
Hydraulic Cabin Pump 举升泵	XINDA V (with lock) 新大威 (带拉锁)	

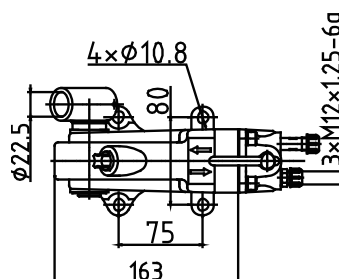



SORL NO. 5003 316 047 0

DESCRIPTION	FOR	OEM NO.
Hydraulic Cabin Pump 举升泵	XINDA V 新大威	

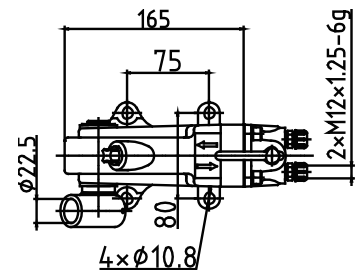

SORL NO. 5003 316 051 0

DESCRIPTION	FOR	OEM NO.
Hydraulic Cabin Pump 举升泵	HAN V D453 悍威D453	5001150-D453

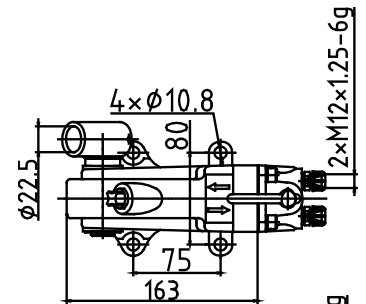

SORL NO. 5003 316 052 0

DESCRIPTION	FOR	OEM NO.
Hydraulic Cabin Pump 举升泵	HAN V (Jingzhou type) 悍威(荆州型)	

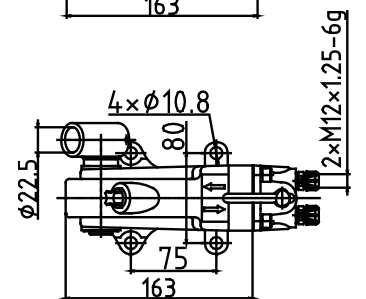

SORL NO. 5003 316 054 0

DESCRIPTION	FOR	OEM NO.
Hydraulic Cabin Pump 举升泵	XINDA V (4-hole) 新大威(四孔)	

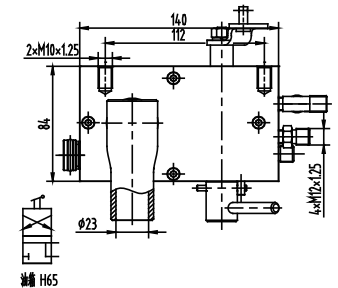

SORL NO. 5003 316 056 0

DESCRIPTION	FOR	OEM NO.
Hydraulic Cabin Pump 举升泵	XINDA V (2-hole with lock) 新大威(二孔带拉锁)	

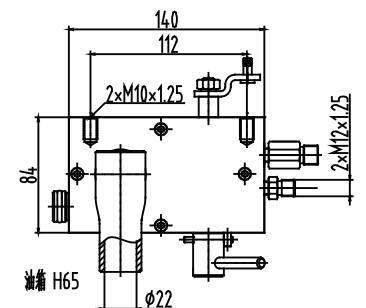

SORL NO. 5003 316 071 0

DESCRIPTION	FOR	OEM NO.
Hydraulic Cabin Pump 举升泵	XINDA V (D840 VERSION 10) 新大威(10款D840)	5001150-D453

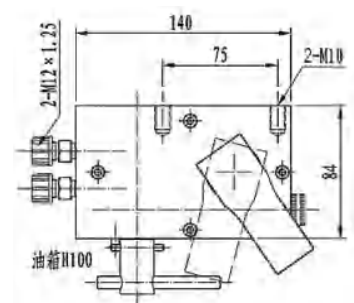



SORL NO. 5003 316 084 0

DESCRIPTION	FOR	OEM NO.
Hydraulic Cabin Pump 举升泵	XINDA V (2-hole with lock) 新大威 (二孔带拉锁)	5001150-D604

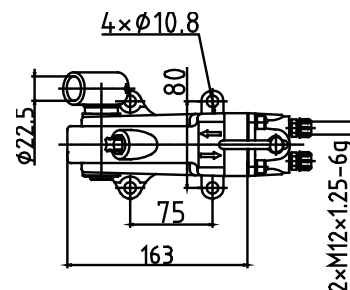

SORL NO. 5003 316 085 0

DESCRIPTION	FOR	OEM NO.
Hydraulic Cabin Pump 举升泵	XINDA V 新大威	5001150-Q318B

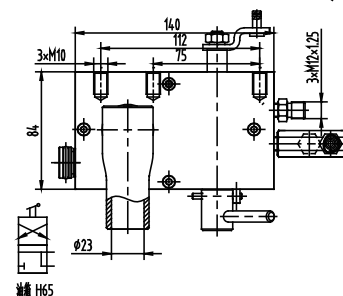

SORL NO. 5003 316 091 0

DESCRIPTION	FOR	OEM NO.
Hydraulic Cabin Pump 举升泵	SMALL J6 (5-hole) 小J6 (五孔)	5002070A29A-C00

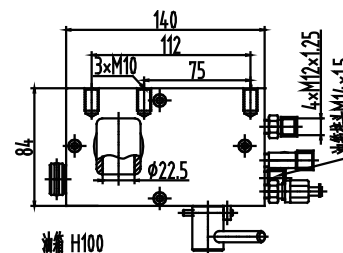

SORL NO. 5003 316 093 0

DESCRIPTION	FOR	OEM NO.
Hydraulic Cabin Pump 举升泵	QINGDAO 青岛一汽	5001150-Q367

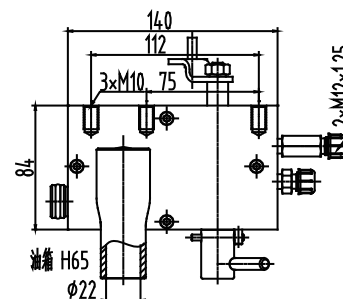

SORL NO. 5003 316 095 0

DESCRIPTION	FOR	OEM NO.
Hydraulic Cabin Pump 举升泵	HAN V (D488 VERSION 11) 悍威 (11款D488)	5001150-D488

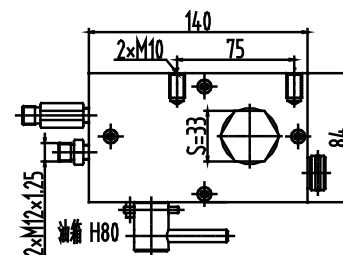

SORL NO. 5003 316 100 0

DESCRIPTION	FOR	OEM NO.
Hydraulic Cabin Pump 举升泵	XINDA V 新大威	5001150-D480

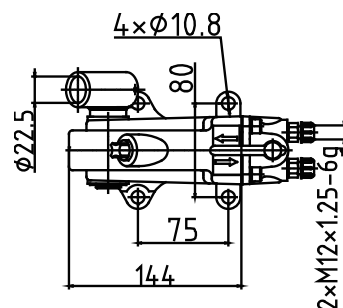



SORL NO. 5003 316 104 0

DESCRIPTION	FOR	OEM NO.
Hydraulic Cabin Pump 举升泵	HAN V (3-hole) 悍威(三孔)	5001A10060

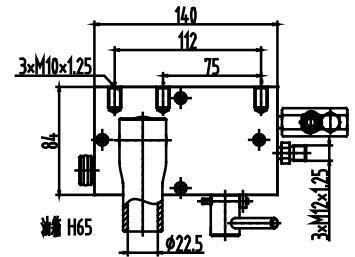

SORL NO. 5003 316 106 0

DESCRIPTION	FOR	OEM NO.
Hydraulic Cabin Pump 举升泵	QINGDAO 青岛一汽	5001170-Q204

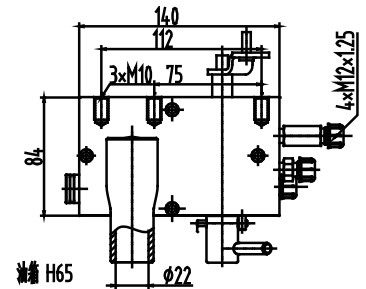

SORL NO. 5003 316 110 0

DESCRIPTION	FOR	OEM NO.
Hydraulic Cabin Pump 举升泵	FAW JH6 (4-hole) 解放JH6(四孔)	5002070A1063-C00

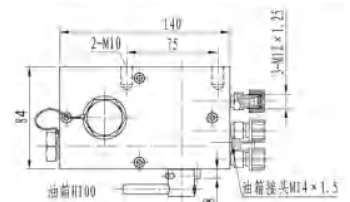

SORL NO. 5003 316 142 0

DESCRIPTION	FOR	OEM NO.
Hydraulic Cabin Pump 举升泵	AO V (4-hole with lock) 奥威(四孔带拉锁)	5001120-Q458

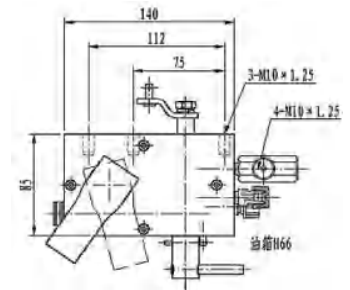

SORL NO. 5003 316 143 0

DESCRIPTION	FOR	OEM NO.
Hydraulic Cabin Pump 举升泵	HAN V (2-hole Jinzhou type) 悍威荆州型(二孔)	5001150-Q802

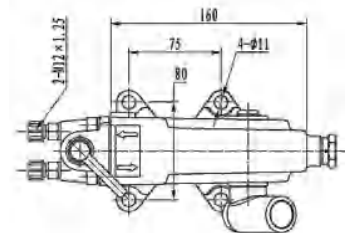

SORL NO. 5003 316 145 0

DESCRIPTION	FOR	OEM NO.
Hydraulic Cabin Pump 举升泵	HAN V D453E (with lock) 悍威D453E(带拉锁)	5001150-D453E 5001901-D453E

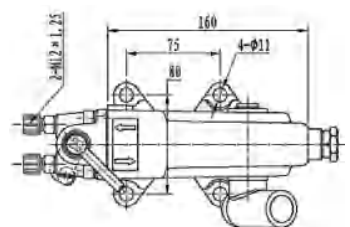



SORL NO. 5003 316 146 0

DESCRIPTION	FOR	OEM NO.
Hydraulic Cabin Pump 举升泵	XINDA V 新大威	

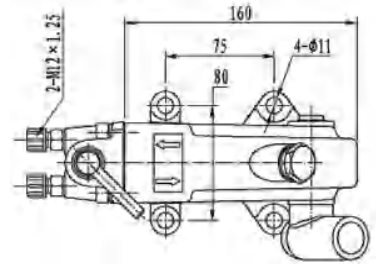

SORL NO. 5003 316 147 0

DESCRIPTION	FOR	OEM NO.
Hydraulic Cabin Pump 举升泵	HAN V D485 悍威D485	5001150-D485

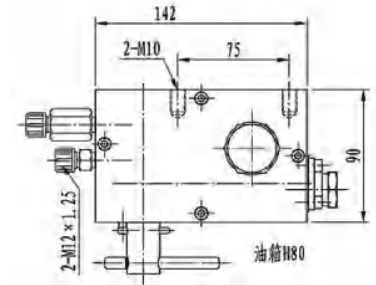

SORL NO. 5003 316 148 0

DESCRIPTION	FOR	OEM NO.
Hydraulic Cabin Pump 举升泵	XINDA V Q181 新大威Q181	5001901-Q181

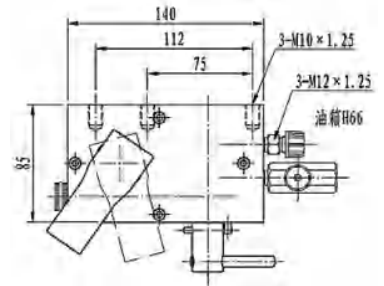

SORL NO. 5003 316 149 0

DESCRIPTION	FOR	OEM NO.
Hydraulic Cabin Pump 举升泵	XINDA V Q408 新大威Q408	5001150-Q408

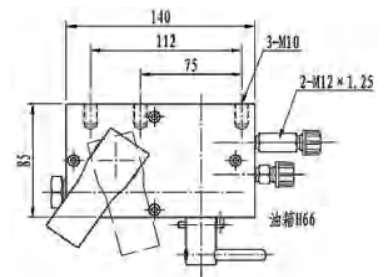

SORL NO. 5003 316 150 0

DESCRIPTION	FOR	OEM NO.
Hydraulic Cabin Pump 举升泵	FAW J6 (5-hole) 解放J6(五孔)	5001070A29A-C00

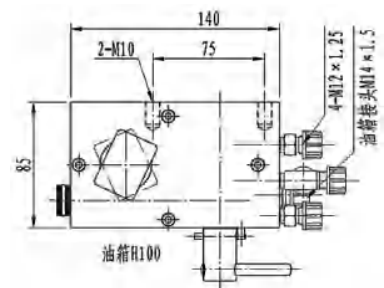

SORL NO. 5003 316 151 0

DESCRIPTION	FOR	OEM NO.
Hydraulic Cabin Pump 举升泵	FAW B91W (5-hole) 解放B91W(五孔)	5002070B91W-C00

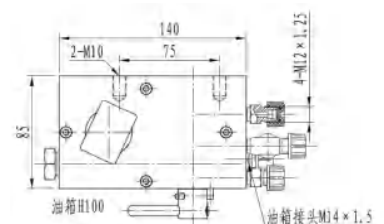



SORL NO. 5003 316 264 0

DESCRIPTION	FOR	OEM NO.
Hydraulic Cabin Pump 举升泵	AO V (2-hole with lock) 奥威(二孔带拉锁)	500170A-362

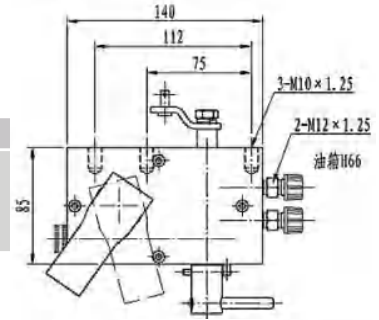

SORL NO. 5003 316 265 0

DESCRIPTION	FOR	OEM NO.
Hydraulic Cabin Pump 举升泵	AO V (3-hole with lock) 奥威(三孔带拉锁)	500120A-Q191

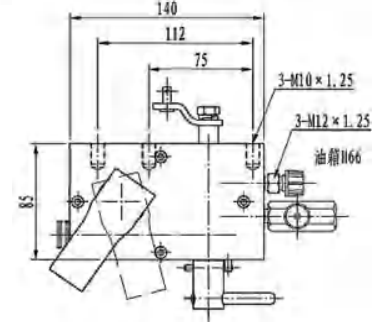

SORL NO. 5003 316 266 0

DESCRIPTION	FOR	OEM NO.
Hydraulic Cabin Pump 举升泵	AO V (4-hole) 奥威(三孔)	5001120-Q148

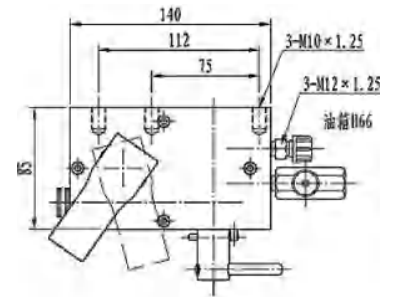

SORL NO. 5003 316 267 0

DESCRIPTION	FOR	OEM NO.
Hydraulic Cabin Pump 举升泵	HAN V (4-hole) 悍威(四孔)	5001170-362

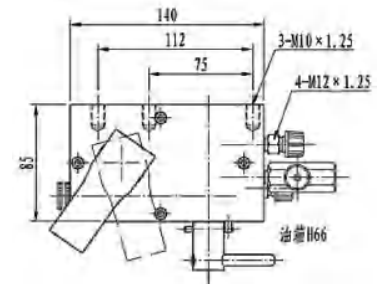

SORL NO. 5003 753 002 0

DESCRIPTION	FOR	OEM NO.
Electric Hydraulic Pump 电动泵	J6(NAVIGATOR e-pump) 解放J6领航版(电动泵)	5002075AA01-C02

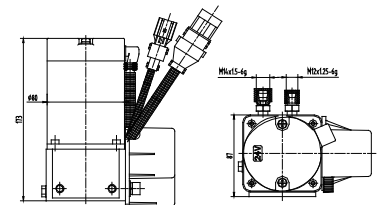

SORL NO. 5003 753 010 0

DESCRIPTION	FOR	OEM NO.
Electric Hydraulic Pump 电动泵	TIAN V(automatic & manual) 解放天威(手自一体泵)	5001150-D979E

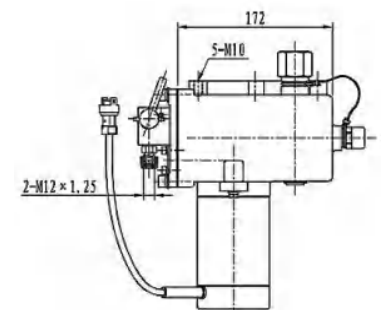



SORL NO. 5003 753 011 0

DESCRIPTION	FOR	OEM NO.
Electric Hydraulic Pump 电动泵	J6 (automatic & manua) J6前四后八(手自一体泵)	5002070AB35J

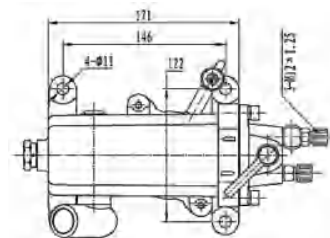

SORL NO. 5003 753 026 0

DESCRIPTION	FOR	OEM NO.
Electric Hydraulic Pump 电动泵	J7 (automatic & manua) 解放J7(手自一体泵)	5002060-2000

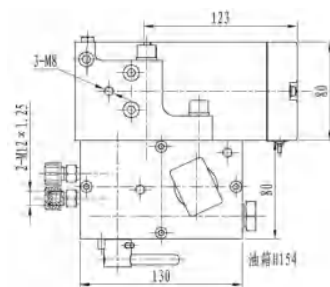

SORL NO. 5003 753 045 0

DESCRIPTION	FOR	OEM NO.
Electric Hydraulic Pump 电动泵	65A (电动泵)	5002180AA01-C00

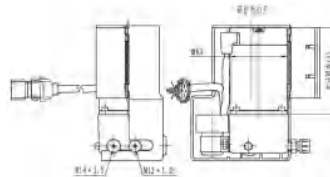

SORL NO. 5003 753 076 0

DESCRIPTION	FOR	OEM NO.
Electric Hydraulic Pump 电动泵	FAW J6 (Electric Pump) 解放J6(电动泵)	5002275AA01

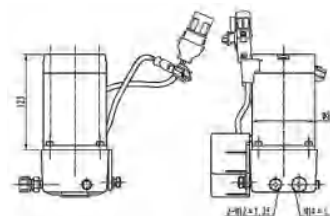

SORL NO. 5003 753 077 0

DESCRIPTION	FOR	OEM NO.
Electric Hydraulic Pump 电动泵	J6 B91W 解放J6 B91W(电动泵)	5002075B91W-C00

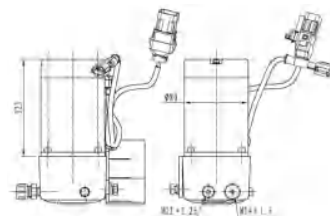

SORL NO. 5003 753 088 0

DESCRIPTION	FOR	OEM NO.
Electric Hydraulic Pump 电动泵	FAW J6 解放J6	5002075B91W-C00/B

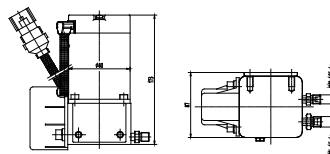



SORL NO. 5003 753 002 8

DESCRIPTION	FOR	OEM NO.
Electric Hydraulic Pump 电动泵	J6 (Old-motor) J6 (新款电机)	5002275AA01

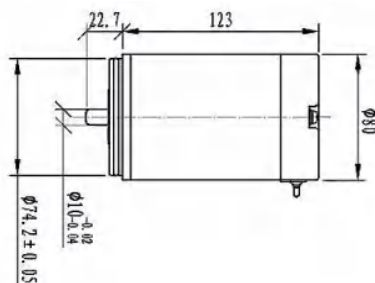

SORL NO. 5003 753 006 5

DESCRIPTION	FOR	OEM NO.
Electric Hydraulic Pump 电动泵	J6 (Pump body assembly) J6 (泵体组件)	5002275AA01

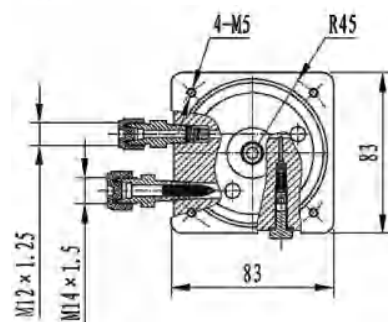

SORL NO. 5003 753 012 5

DESCRIPTION	FOR	OEM NO.
Electric Hydraulic Pump 电动泵	J6 (Old-motor) J6 (老款电机)	5002275AA01

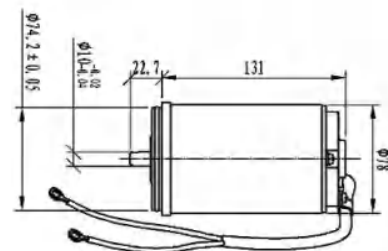

SORL NO. 5004 C1 001 0

DESCRIPTION	FOR	OEM NO.
Cabin Latch 液压锁	FAW J6 解放J6	5004060-A01



SORL NO. 5004 C1 002 0

DESCRIPTION	FOR	OEM NO.
Cabin Latch 液压锁	XINDAWEI 新大威	5004060-Q408



SORL NO. 5004 C1 003 0

DESCRIPTION	FOR	OEM NO.
Cabin Latch 液压锁	XINDAWEI 10 新大威10款	5001300-D643Q

**SORL NO. 5004 C1 004 0**

DESCRIPTION	FOR	OEM NO.
Cabin Latch 液压锁	FAW 解放 HANEI 悍威 AOWEI 奥威 SIDA 四大	5001300-D643Q

**SORL NO. 5004 C1 006 0**

DESCRIPTION	FOR	OEM NO.
Cabin Latch 液压锁	FAW JH6 解放JH6	5004055-1063

**SORL NO. 5004 C1 007 0**

DESCRIPTION	FOR	OEM NO.
Cabin Latch 液压锁	FAW J6P NAVIGATE 解放J6P领航版	5004055-B91W

**SORL NO. 5004 C1 008 0**

DESCRIPTION	FOR	OEM NO.
Cabin Latch 液压锁	FAW Tian V 解放天V	5004055-E18

**SORL NO. 5004 C1 009 0**

DESCRIPTION	FOR	OEM NO.
Cabin Latch 液压锁	FAW 解放	5004060-A65

**SORL NO. 5004 C1 010 0**

DESCRIPTION	FOR	OEM NO.
Cabin Latch 液压锁	FAW J6L 解放J6L	5004060-A86



SORL NO. 5004 C1 011 0

DESCRIPTION	FOR	OEM NO.
Cabin Latch 液压锁	XINDAWEI 10 (Double-decker) 新大威10款(双层)	5001300-D643Q

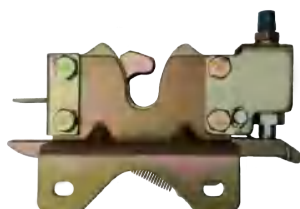

SORL NO. 5004 C1 012 0

DESCRIPTION	FOR	OEM NO.
Cabin Latch 液压锁	XINDAWEI 新悍威	5004060-B109

SERIES DONGFENG 二汽系列



SORL NO. 5003 132 001 0

DESCRIPTION	FOR	OEM NO.
Cabin Cylinder 举升缸	TIANJING (main) 东风大天锦(主缸)	5003010-C1103

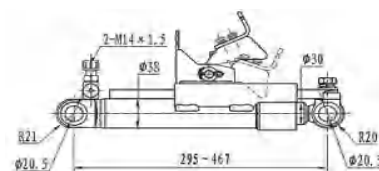

SORL NO. 5003 132 002 0

DESCRIPTION	FOR	OEM NO.
Cabin Cylinder 举升缸	TIANJING(slave) 东风大天锦(副缸)	5003011-C1103

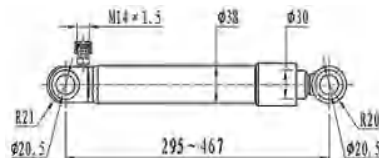

SORL NO. 5003 132 004 0

DESCRIPTION	FOR	OEM NO.
Cabin Cylinder 举升缸	TIANJING (main) 东风小天锦(主缸)	5003010-C1300

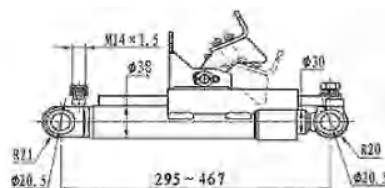



SORL NO. 5003 132 005 0

DESCRIPTION	FOR	OEM NO.
Cabin Cylinder 举升缸	TIANJING(slave) 东风小天锦(副缸)	5003011-C1300

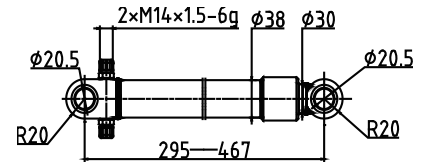

SORL NO. 5003 140 036 0

DESCRIPTION	FOR	OEM NO.
Cabin Cylinder 举升缸	HERCULES 东风大力神	5003010-C0100

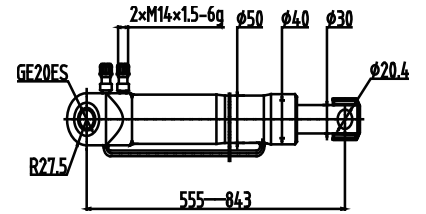

SORL NO. 5003 140 037 0

DESCRIPTION	FOR	OEM NO.
Cabin Cylinder 举升缸	KINLAND(main) 东风天龙(主缸)	5003010-C0300

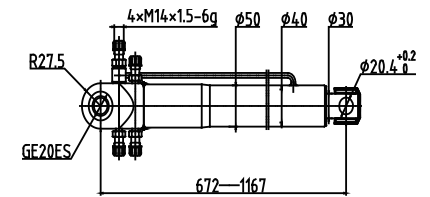

SORL NO. 5003 140 038 0

DESCRIPTION	FOR	OEM NO.
Cabin Cylinder 举升缸	KINLAND(slave) 东风天龙(副缸)	5003011-C0300

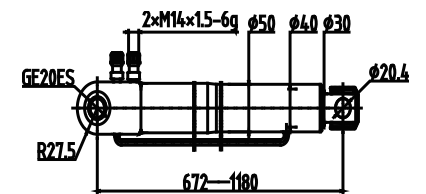

SORL NO. 5003 140 056 0

DESCRIPTION	FOR	OEM NO.
Cabin Cylinder 举升缸	KINLAND (single) 东风天龙(单缸)	5003010-C0101

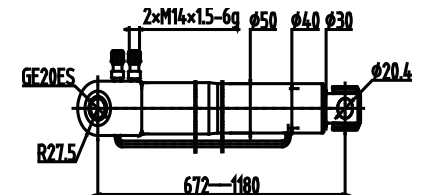

SORL NO. 5003 140 057 0

DESCRIPTION	FOR	OEM NO.
Cabin Cylinder 举升缸	KINLAND(main) 东风天龙新款(主缸)	5003010-C4300

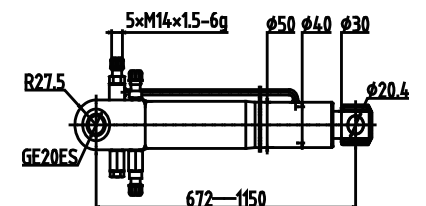



SORL NO. 5003 140 058 0

DESCRIPTION	FOR	OEM NO.
Cabin Cylinder 举升缸	KINLAND(slave) 东风天龙新款(副缸)	5003011-C4300

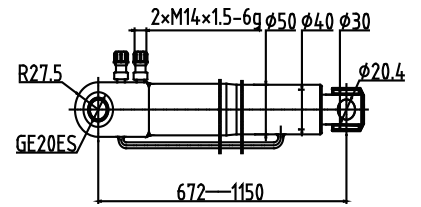

SORL NO. 5003 140 111 0

DESCRIPTION	FOR	OEM NO.
Cabin Cylinder 举升缸	CUMMINS 康明斯153(单缸)	50Z07-03010B

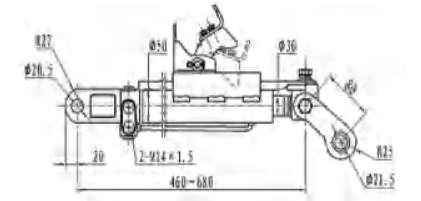

SORL NO. 5003 140 115 0

DESCRIPTION	FOR	OEM NO.
Cabin Cylinder 举升缸	TIANJIN 东风天锦	5003910-C1800

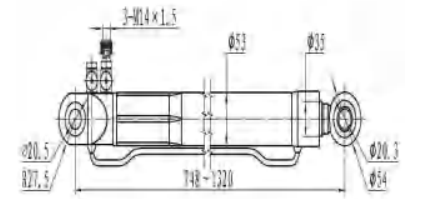

SORL NO. 5003 140 118 0

DESCRIPTION	FOR	OEM NO.
Cabin Cylinder 举升缸	KINLAND(main) 东风天龙最新(主缸)	5003910-C4300

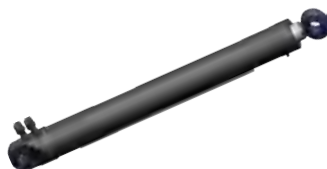
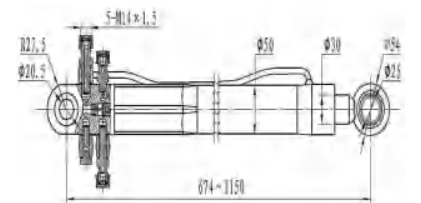

SORL NO. 5003 140 119 0

DESCRIPTION	FOR	OEM NO.
Cabin Cylinder 举升缸	KINLAND(slave) 东风天龙最新(副缸)	5003920-C4300

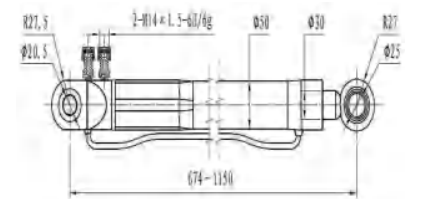

SORL NO. 5003 140 121 0

DESCRIPTION	FOR	OEM NO.
Cabin Cylinder 举升缸	YANLONG(main) 东风炎龙(主缸)	5002020A0-N062

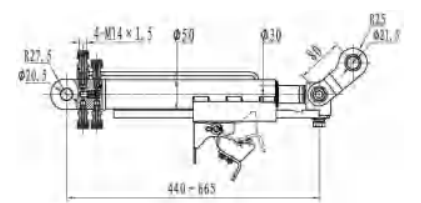



SORL NO. 5003 140 122 0

DESCRIPTION	FOR	OEM NO.
Cabin Cylinder 举升缸	YANLONG(slave) 东风炎龙(副缸)	50ZB1-12303011S

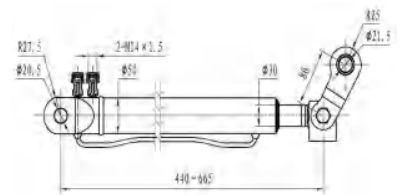

SORL NO. 5003 140 123 0

DESCRIPTION	FOR	OEM NO.
Cabin Cylinder 举升缸	SPECIAL VEHICLE 东风特商	

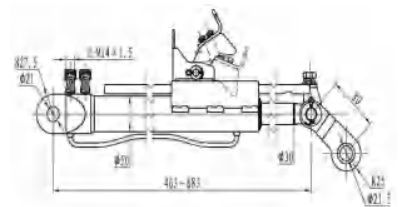

SORL NO. 5003 140 124 0

DESCRIPTION	FOR	OEM NO.
Cabin Cylinder 举升缸	TIANJIN(main) 东风天锦(主缸)	5003010-C1104

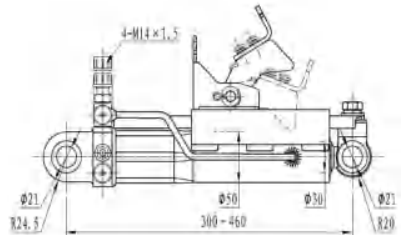

SORL NO. 5003 140 125 0

DESCRIPTION	FOR	OEM NO.
Cabin Cylinder 举升缸	TIANJIN(slave) 东风天锦(副缸)	5003011-C1104

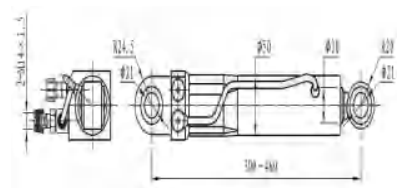

SORL NO. 5003 145 003 0

DESCRIPTION	FOR	OEM NO.
Cabin Cylinder 举升缸	Flagship 东风旗舰	5003910-C6100

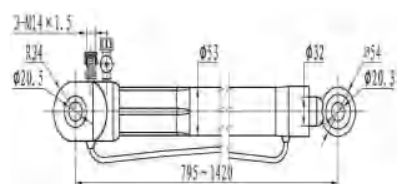

SORL NO. 5003 316 005 0

DESCRIPTION	FOR	OEM NO.
Hydraulic Cabin Pump 举升泵	KINLAND(5-hole) 东风天龙(五孔)	5005010-C0100

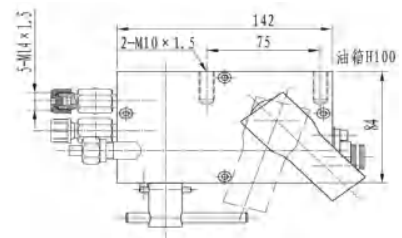



SORL NO. 5003 316 007 0

DESCRIPTION	FOR	OEM NO.
Hydraulic Cabin Pump 举升泵	KINLAND(3-hole) 东风天龙 (三孔)	5005010-C0300

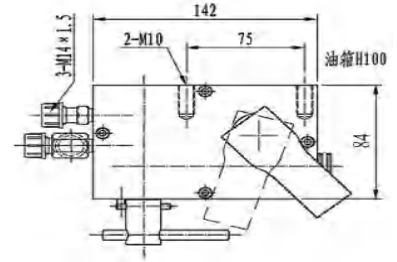

SORL NO. 5003 316 035 0

DESCRIPTION	FOR	OEM NO.
Hydraulic Cabin Pump 举升泵	CUMMINS 153 康明斯153 (圆型)	50Z07-05010

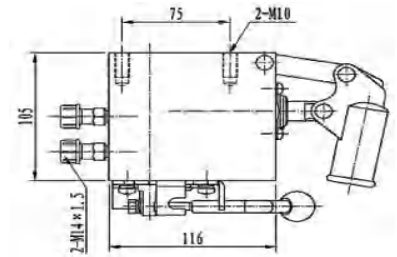

SORL NO. 5003 316 037 0

DESCRIPTION	FOR	OEM NO.
Hydraulic Cabin Pump 举升泵	TIANJIN(3-hole) 东风天锦 (三孔)	5005010-C1101

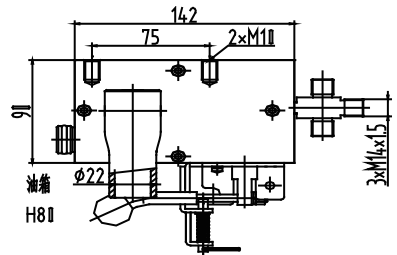

SORL NO. 5003 316 040 0

DESCRIPTION	FOR	OEM NO.
Hydraulic Cabin Pump 举升泵	KINLAND(2-hole) 东风天龙 (二孔)	

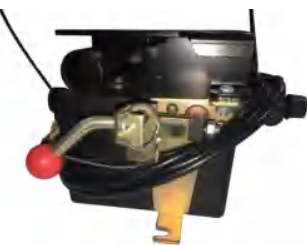
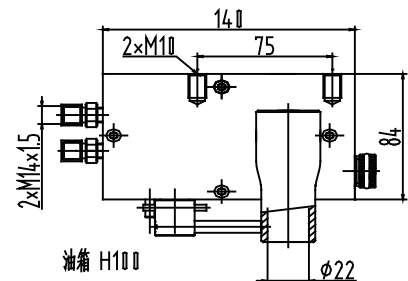

SORL NO. 5003 316 058 0

DESCRIPTION	FOR	OEM NO.
Hydraulic Cabin Pump 举升泵	TIANJIN(big) 东风天锦 (大)	5005010-C1101

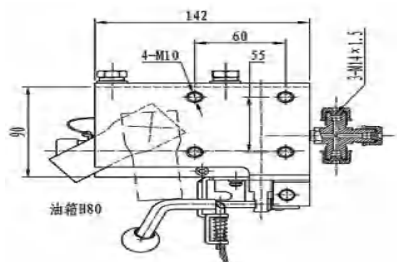

SORL NO. 5003 316 189 0

DESCRIPTION	FOR	OEM NO.
Hydraulic Cabin Pump 举升泵	TIANLONG (bigger oil box) 东风天龙 (加大油箱)	5005011-C4300

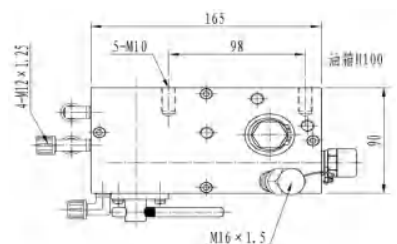



SORL NO. 5003 316 112 0

DESCRIPTION	FOR	OEM NO.
Hydraulic Cabin Pump 举升泵	TIANLONG 东风天龙	5005011-C4300

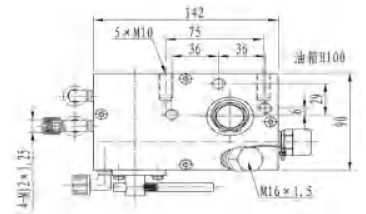

SORL NO. 5003 316 153 0

DESCRIPTION	FOR	OEM NO.
Hydraulic Cabin Pump 举升泵	VIOLET(2-hole) 东风紫罗兰(二孔)	50Z07-05010-B

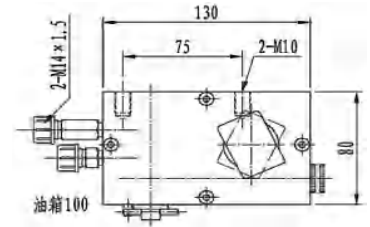

SORL NO. 5003 316 154 0

DESCRIPTION	FOR	OEM NO.
Hydraulic Cabin Pump 举升泵	153 (square) 东风153(方型)	50ZB105010-B

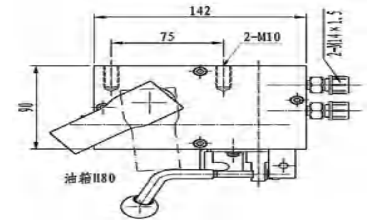

SORL NO. 5003 316 155 0

DESCRIPTION	FOR	OEM NO.
Hydraulic Cabin Pump 举升泵	YANLONG(2-hole) 东风炎龙(二孔)	5005011-T0100

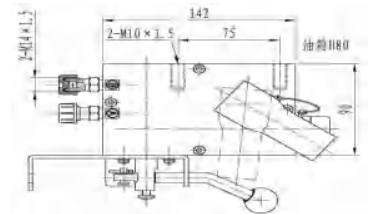

SORL NO. 5003 316 157 0

DESCRIPTION	FOR	OEM NO.
Hydraulic Cabin Pump 举升泵	TIANJIN(small) 东风天锦(小)	5005010-C1300

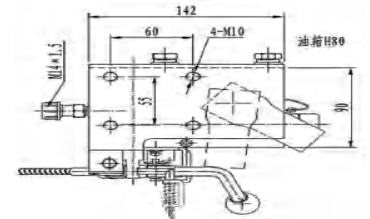

SORL NO. 5003 316 158 0

DESCRIPTION	FOR	OEM NO.
Hydraulic Cabin Pump 举升泵	153 (3-hole square) 东风153(方型三孔)	5005010-EE0301

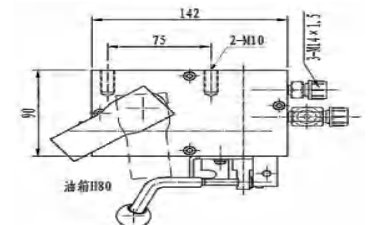



SORL NO. 5003 316 159 0

DESCRIPTION	FOR	OEM NO.
Hydraulic Cabin Pump 举升泵	YANLONG(3-hole) 东风炎龙(三孔)	5005010-T0100

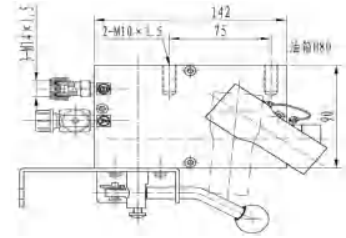

SORL NO. 5003 316 160 0

DESCRIPTION	FOR	OEM NO.
Hydraulic Cabin Pump 举升泵	C6100 东风C6100	5005010-C6100

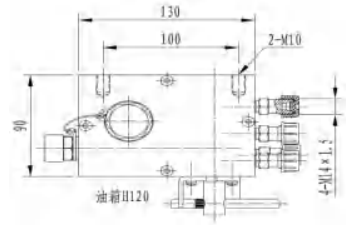

SORL NO. 5003 316 161 0

DESCRIPTION	FOR	OEM NO.
Hydraulic Cabin Pump 举升泵	TIANJIN(export) 天锦出口车	5005010-C1200

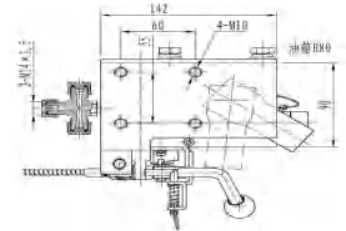

SORL NO. 5003 316 162 0

DESCRIPTION	FOR	OEM NO.
Hydraulic Cabin Pump 举升泵	TIANJIN C1103 天锦C1103	5005010-C1103

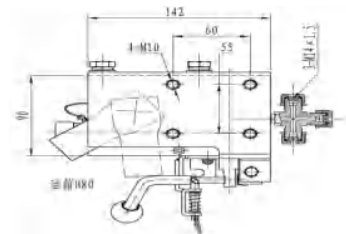

SORL NO. 5003 316 163 0

DESCRIPTION	FOR	OEM NO.
Hydraulic Cabin Pump 举升泵	TIANJIN C1105 天锦C1105	5005010-C1105

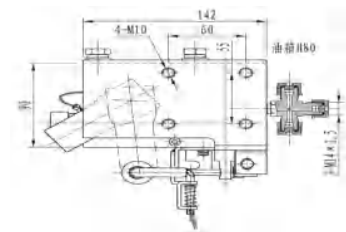

SORL NO. 5003 316 164 0

DESCRIPTION	FOR	OEM NO.
Hydraulic Cabin Pump 举升泵	TIANJIN C1110 天锦C1110	5005010-C1110

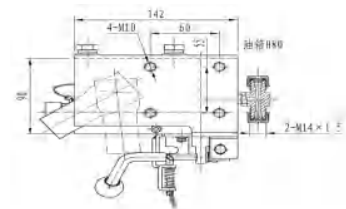



SORL NO. 5003 316 165 0

DESCRIPTION	FOR	OEM NO.
Hydraulic Cabin Pump 举升泵	TIANJIN (generation3) 天锦三代	5005010-C1800

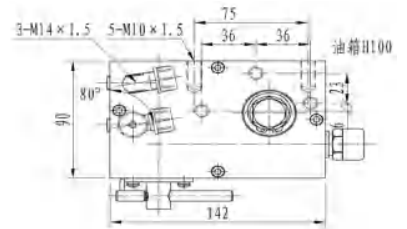

SORL NO. 5003 316 167 0

DESCRIPTION	FOR	OEM NO.
Hydraulic Cabin Pump 举升泵	TIANJIN C1104 天锦C1104	5005010-C1104

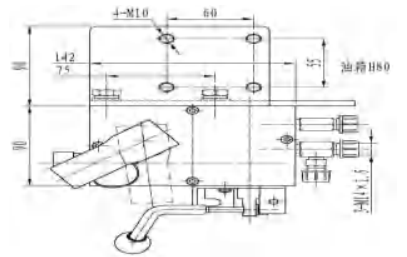

SORL NO. 5003 316 168 0

DESCRIPTION	FOR	OEM NO.
Hydraulic Cabin Pump 举升泵	TIANJIN(5-hone) 天锦(五孔)	

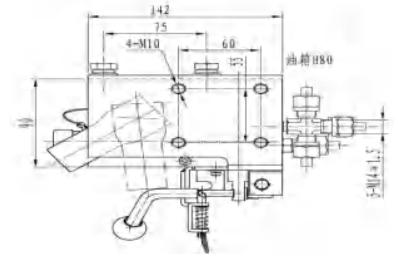

SORL NO. 5003 753 027 0

DESCRIPTION	FOR	OEM NO.
Electric Hydraulic Pump 电动泵	TIANLONG (combination) 东风天龙(组合泵)	5005011-C4300

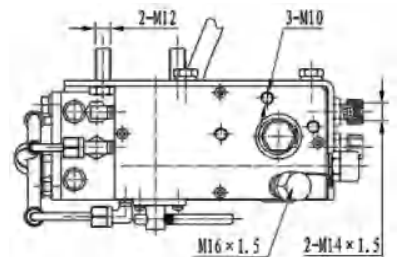

SORL NO. 5003 753 030 0

DESCRIPTION	FOR	OEM NO.
Electric Hydraulic Pump 电动泵	J6 NAVIGATOR JH6领航版	5002075AA01

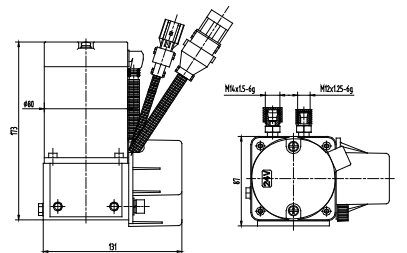

SORL NO. 5003 753 046 0

DESCRIPTION	FOR	OEM NO.
Electric Hydraulic Pump 电动泵	DONGFENG (combination) 东风(组合泵)	5005010-C1102

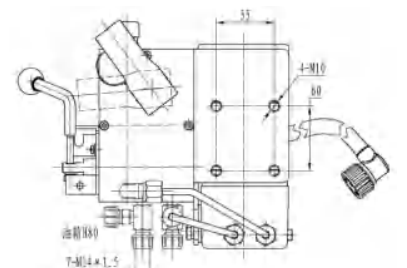



SORL NO. 5003 753 078 0

DESCRIPTION	FOR	OEM NO.
Electric Hydraulic Pump 电动泵	TIANDONG (combination) 天龙(组合泵)	5005011-C0300 5005011-C0301

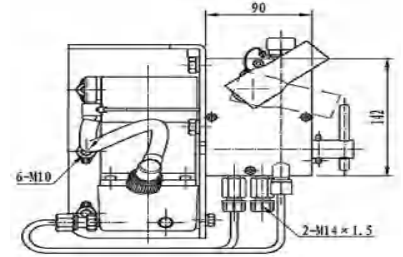

SORL NO. 5003 753 079 0

DESCRIPTION	FOR	OEM NO.
Electric Hydraulic Pump 电动泵	DONGFENG (e-pump) 东风天龙(电动泵)	5005011-C0300

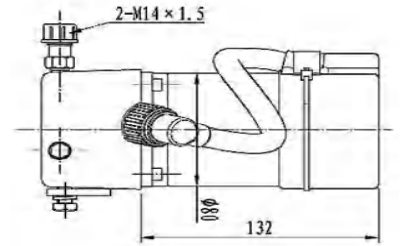

SORL NO. 5003 753 014 5

DESCRIPTION	FOR	OEM NO.
Electric Hydraulic Pump 电动泵	DONGFENG (e-pump) 东风天龙(电机)	5005011-C0300

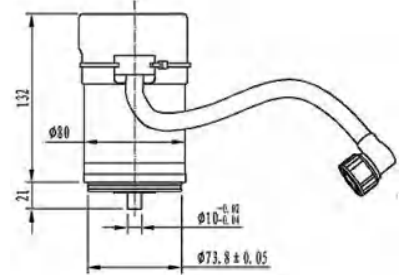

SORL NO. 5004 C2 001 0

DESCRIPTION	FOR	OEM NO.
Cabin Latch 液压锁	TIANJIN(right) 天锦(右)	5002175-C1100



SORL NO. 5004 C2 002 0

DESCRIPTION	FOR	OEM NO.
Cabin Latch 液压锁	TIANJIN(left) 天锦(左)	5002170-C1100



SORL NO. 5004 C2 003 0

DESCRIPTION	FOR	OEM NO.
Cabin Latch 液压锁	TIANLONG(right) 东风天龙(右)	5002175-C0100

**SORL NO. 5004 C2 004 0**

DESCRIPTION	FOR	OEM NO.
Cabin Latch 液压锁	TIANLONG(left) 东风天龙(左)	5002170-C0100

**SORL NO. 5004 C2 005 0**

DESCRIPTION	FOR	OEM NO.
Cabin Latch 液压锁	TIANLONG 12 (left) 东风天龙12款(左)	5002175-C4300

**SORL NO. 5004 C2 006 0**

DESCRIPTION	FOR	OEM NO.
Cabin Latch 液压锁	TIANLONG 12 (right) 东风天龙12款(右)	5002170-C4300

**SORL NO. 5004 C2 007 0**

DESCRIPTION	FOR	OEM NO.
Cabin Latch 液压锁	Flagship (left) 东风旗舰版(左)	5002160-C6100

**SORL NO. 5004 C2 008 0**

DESCRIPTION	FOR	OEM NO.
Cabin Latch 液压锁	Flagship (right) 东风旗舰版(右)	5002165-C6100

**SORL NO. 5004 C2 009 0**

DESCRIPTION	FOR	OEM NO.
Cabin Latch 液压锁	TIANJIN KR(left) 天锦KR(左)	5002170-C5100



SORL NO. 5004 C2 010 0

DESCRIPTION	FOR	OEM NO.
Cabin Latch 液压锁	TIANJIN KR(right) 天锦KR(右)	5002175-C5100



SORL NO. 5004 C2 011 0

DESCRIPTION	FOR	OEM NO.
Cabin Latch 液压锁	NEW TIANJIN(left) 天锦新款(左)	5002175-C1102



SORL NO. 5004 C2 012 0

DESCRIPTION	FOR	OEM NO.
Cabin Latch 液压锁	NEW TIANJIN(right) 天锦新款(右)	5002170-C1102

SERIES FOTON 福田系列



SORL NO. 5003 140 032 0

DESCRIPTION	FOR	OEM NO.
Cabin Cylinder 举升缸	AUMAN 欧曼	1B24950200008

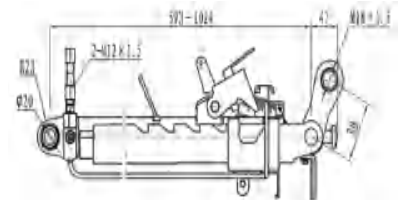

SORL NO. 5003 140 033 0

DESCRIPTION	FOR	OEM NO.
Cabin Cylinder 举升缸	AUMAN ETX 欧曼ETX	1B24950280031

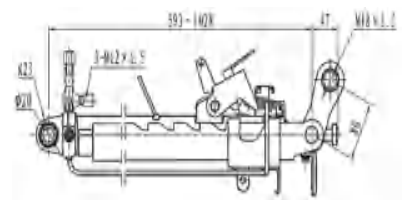



SORL NO. 5003 140 095 0

DESCRIPTION	FOR	OEM NO.
Cabin Cylinder 举升缸	AUMAN GTL(slave) 欧曼GTL(副缸)	H4502C02003A0

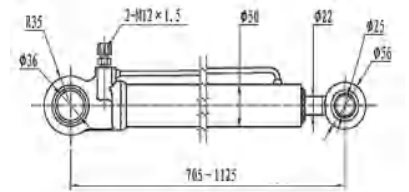

SORL NO. 5003 140 097 0

DESCRIPTION	FOR	OEM NO.
Cabin Cylinder 举升缸	AUMAN (reverse) 欧曼(反方向)	1B24950200008

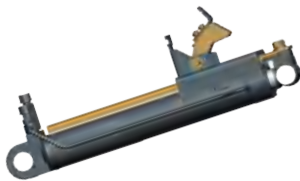
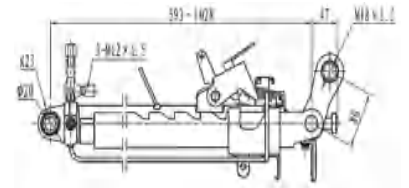

SORL NO. 5003 140 222 0

DESCRIPTION	FOR	OEM NO.
Cabin Cylinder 举升缸	ROWOR 瑞沃	G0502C02001A0

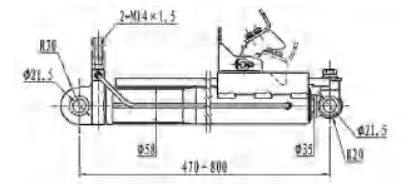

SORL NO. 5003 150 033 0

DESCRIPTION	FOR	OEM NO.
Cabin Cylinder 举升缸	AUMAN GTL (main) 欧曼GTL(单缸)	H4502C02001A0

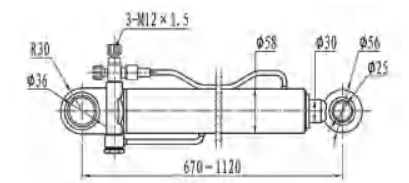

SORL NO. 5003 150 034 0

DESCRIPTION	FOR	OEM NO.
Cabin Cylinder 举升缸	AUMAN GTL (main) 欧曼GTL(主缸)	H4502C02002A0

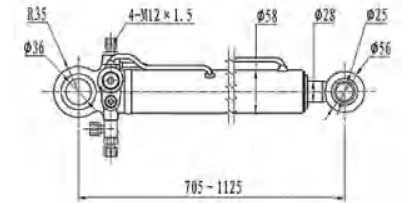

SORL NO. 5003 316 032 0

DESCRIPTION	FOR	OEM NO.
Hydraulic Cabin Pump 举升泵	AUMAN 欧曼	1B24950200181

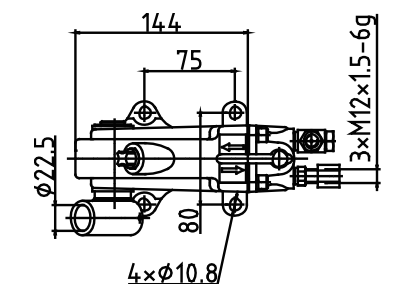



SORL NO. 5003 316 033 0

DESCRIPTION	FOR	OEM NO.
Hydraulic Cabin Pump 举升泵	AUMAN(big) 欧曼(大)	1B24950200181(大)

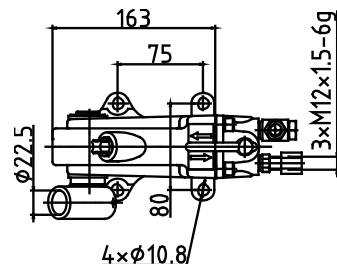

SORL NO. 5003 316 034 0

DESCRIPTION	FOR	OEM NO.
Hydraulic Cabin Pump 举升泵	AUMAN ETX (hexagon) 欧曼ETX(六角)	1B24950200265

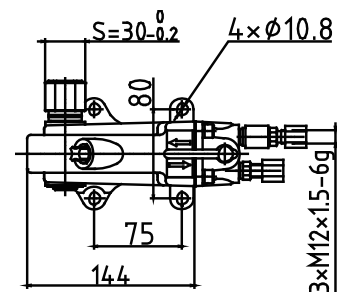

SORL NO. 5003 316 043 0

DESCRIPTION	FOR	OEM NO.
Hydraulic Cabin Pump 举升泵	AUMAN ETX 欧曼ETX	1B24950200254

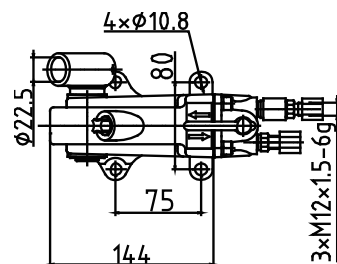

SORL NO. 5003 316 092 0

DESCRIPTION	FOR	OEM NO.
Hydraulic Cabin Pump 举升泵	AUMAN ETX(reverse) 欧曼ETX(反方向)	

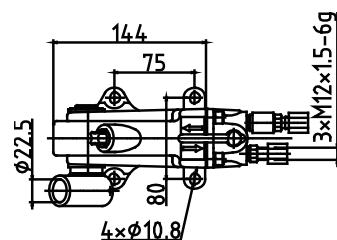

SORL NO. 5003 316 137 0

DESCRIPTION	FOR	OEM NO.
Hydraulic Cabin Pump 举升泵	ROWOR 瑞沃	NHG50KFN735-02340

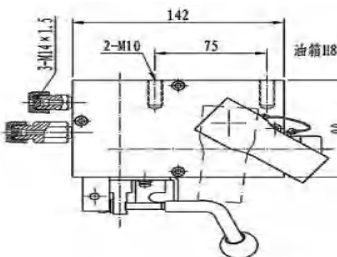

SORL NO. 5003 316 138 0

DESCRIPTION	FOR	OEM NO.
Hydraulic Cabin Pump 举升泵	AUMAN(3-hole) 欧曼(三孔)	H4502C01002A

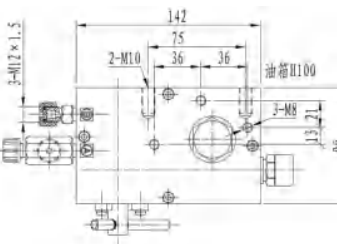



SORL NO. 5003 316 139 0

DESCRIPTION	FOR	OEM NO.
Hydraulic Cabin Pump 举升泵	AUMAN(5-hole) 欧曼(五孔)	H4504020104A0

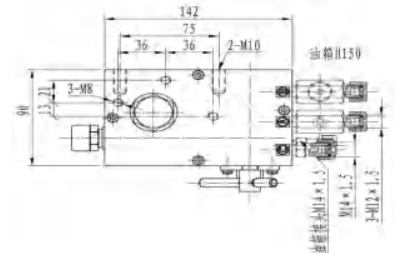

SORL NO. 5003 316 140 0

DESCRIPTION	FOR	OEM NO.
Hydraulic Cabin Pump 举升泵	AUMAN(5-hole) 欧曼(五孔)	H0504020102A0

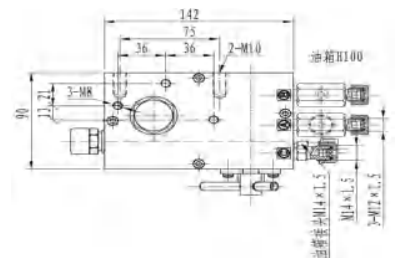

SORL NO. 5003 316 263 0

DESCRIPTION	FOR	OEM NO.
Hydraulic Cabin Pump 举升泵	AUMAN ETX 欧曼ETX	H1502C01101A0

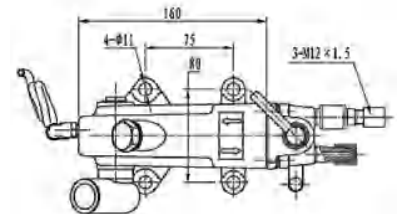

SORL NO. 5003 753 018 0

DESCRIPTION	FOR	OEM NO.
Electric Hydraulic Pump 电动泵	AUMAN (automatic & manual) 欧曼(手自一体泵)	1B24950200057

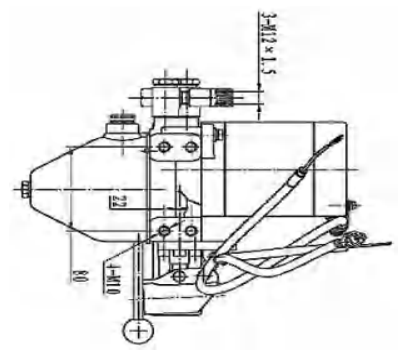

SORL NO. 5003 753 022 0

DESCRIPTION	FOR	OEM NO.
Electric Hydraulic Pump 电动泵	AUMAN GTL (automatic & manual) 欧曼GTL(手自一体泵)	H4502C01001A0

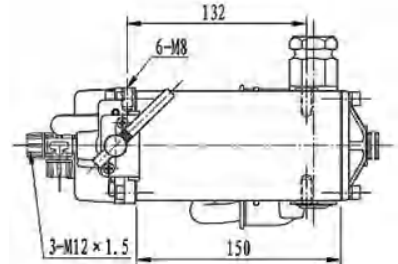

SORL NO. 5003 753 023 0

DESCRIPTION	FOR	OEM NO.
Electric Hydraulic Pump 电动泵	AUMAN GTL (automatic & manual) 欧曼GTL(手自一体泵)	H4502C01005A0

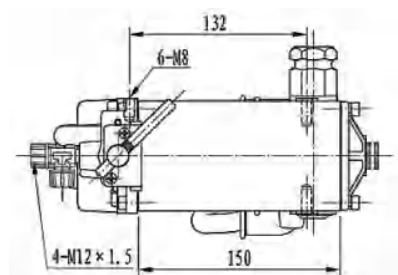



SORL NO. 5003 753 028 0

DESCRIPTION	FOR	OEM NO.
Electric Hydraulic Pump 电动泵	AUMAN (automatic & manual) 欧曼(手自一体泵)	H0502C01012A0

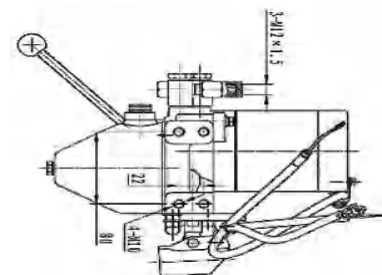

SORL NO. 5003 753 071 0

DESCRIPTION	FOR	OEM NO.
Electric Hydraulic Pump 电动泵	AUMAN GTL (automatic & manual) 欧曼GTL(手自一体泵)	H4502C01004A0

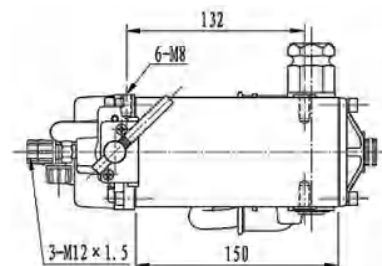

SORL NO. 5003 753 072 0

DESCRIPTION	FOR	OEM NO.
Electric Hydraulic Pump 电动泵	AUMAN GTL (automatic & manual) 欧曼GTL(手自一体泵)	H0502C01011A0

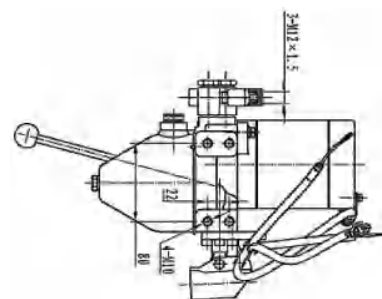

SORL NO. 5003 753 073 0

DESCRIPTION	FOR	OEM NO.
Electric Hydraulic Pump 电动泵	AUMAN (automatic & manual) 欧曼(手自一体泵)	H0502C01013A0

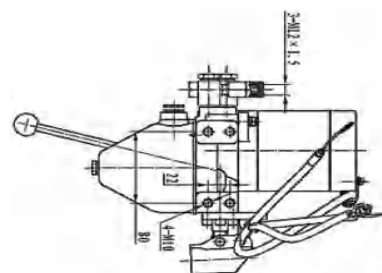

SORL NO. 5003 753 074 0

DESCRIPTION	FOR	OEM NO.
Electric Hydraulic Pump 电动泵	AUMAN GTL (automatic & manual) 欧曼GTL(手自一体泵)	H0504020300A0

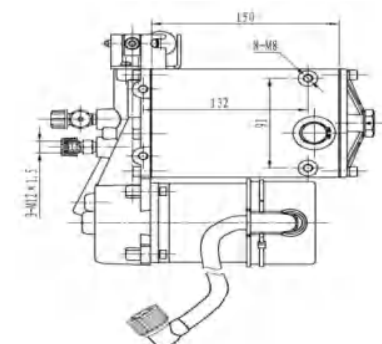

SORL NO. 5003 753 075 0

DESCRIPTION	FOR	OEM NO.
Electric Hydraulic Pump 电动泵	AUMAN (e-pump) 欧曼(电动泵)	H4502C01008A0

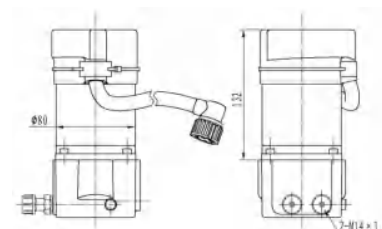



SORL NO. 5004 C5 001 0

DESCRIPTION	FOR	OEM NO.
Cabin Latch 液压锁	AUMAN 欧曼	1B24950200169



SORL NO. 5004 C5 003 0

DESCRIPTION	FOR	OEM NO.
Cabin Latch 液压锁	AUMAN GTL 欧曼GTL	H4502B01017A0



SORL NO. 5004 C5 004 0

DESCRIPTION	FOR	OEM NO.
Cabin Latch 液压锁	OUMAN NEW STYLE 欧曼EST新款	H4502B01047A0



SORL NO. 5004 C5 005 0

DESCRIPTION	FOR	OEM NO.
Cabin Latch 液压锁	OUMAN GTL 欧曼GTL	H4502B01017A05201

SERIES LIUZHOU AUTO 柳汽系列



SORL NO. 5003 136 008 0

DESCRIPTION	FOR	OEM NO.
Cabin Cylinder 举升缸	CHENGLONG(long) 乘龙(长缸)	MG401-5002020

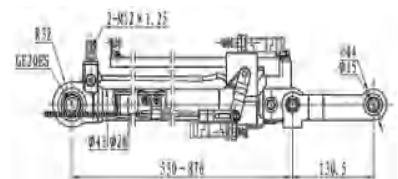



SORL NO. 5003 136 009 0

DESCRIPTION	FOR	OEM NO.
Cabin Cylinder 举升缸	CHENGLONG(short) 乘龙(短缸)	M3Q-5002020

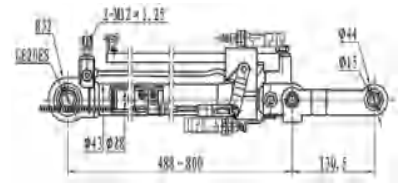

SORL NO. 5003 140 059 0

DESCRIPTION	FOR	OEM NO.
Cabin Cylinder 举升缸	BALONG(main) 霸龙(主缸)	M5Q-5002200

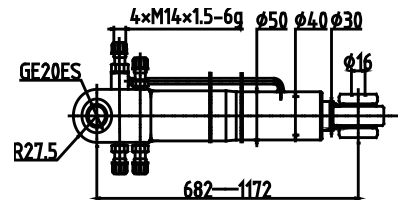

SORL NO. 5003 140 060 0

DESCRIPTION	FOR	OEM NO.
Cabin Cylinder 举升缸	BALONG(slave) 霸龙(副缸)	M5Q-5002300

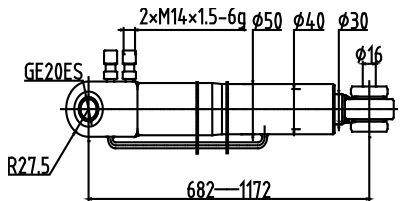

SORL NO. 5003 140 135 0

DESCRIPTION	FOR	OEM NO.
Cabin Cylinder 举升缸	BALONG H7 霸龙H7	H73-5002200

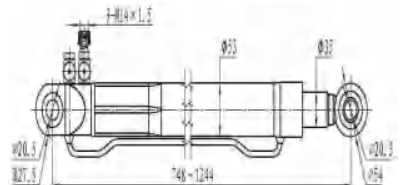

SORL NO. 5003 140 136 0

DESCRIPTION	FOR	OEM NO.
Cabin Cylinder 举升缸	BALONG H7 霸龙H7	H73-5002300C

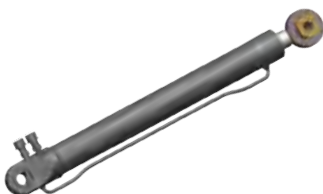
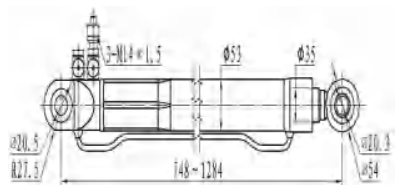

SORL NO. 5003 140 137 0

DESCRIPTION	FOR	OEM NO.
Cabin Cylinder 举升缸	BALONG H7 霸龙H7	M31A-5002200B

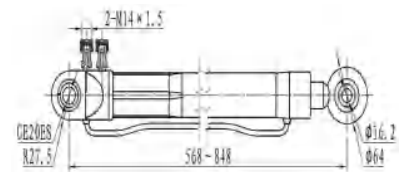



SORL NO. 5003 316 062 0

DESCRIPTION	FOR	OEM NO.
Hydraulic Cabin Pump 举升泵	BALONG(4-hole) 柳汽霸龙H7 (四孔)	H73-5002400A

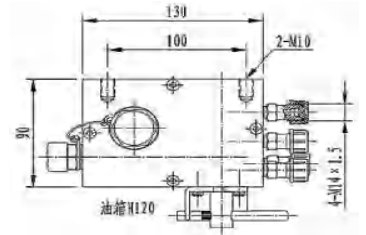

SORL NO. 5003 316 089 0

DESCRIPTION	FOR	OEM NO.
Hydraulic Cabin Pump 举升泵	BALONG 柳汽霸龙	M5Q-5002400C

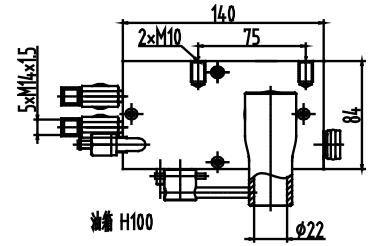

SORL NO. 5003 316 090 0

DESCRIPTION	FOR	OEM NO.
Hydraulic Cabin Pump 举升泵	BALONG(5-hole) 柳汽霸龙 (五孔)	M6B-5002400C

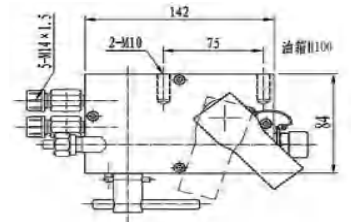

SORL NO. 5003 316 098 0

DESCRIPTION	FOR	OEM NO.
Hydraulic Cabin Pump 举升泵	CHENGLONG MG401 柳汽乘龙MG401	MG401-5002050B

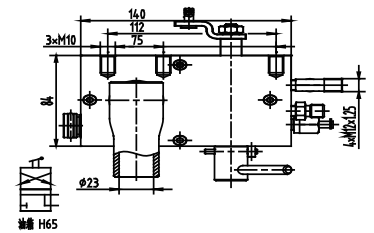

SORL NO. 5003 316 099 0

DESCRIPTION	FOR	OEM NO.
Hydraulic Cabin Pump 举升泵	CHENGLONG 柳汽乘龙	M6B-5002400B

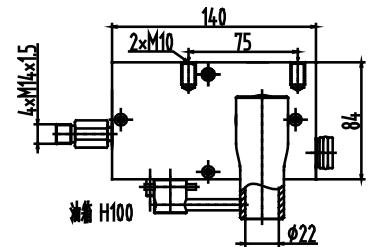

SORL NO. 5003 316 179 0

DESCRIPTION	FOR	OEM NO.
Hydraulic Cabin Pump 举升泵	LIUZHOU AUTO (4-hole with lock) 柳汽(四孔带拉锁)	CLDPMG401-5002050

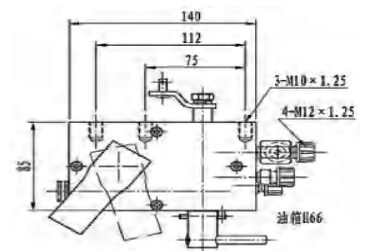



SORL NO. 5003 316 180 0

DESCRIPTION	FOR	OEM NO.
Hydraulic Cabin Pump 举升泵	BALONG (4-hole with lock) 柳汽霸龙 (四孔带拉锁开关)	MG401-5002050A

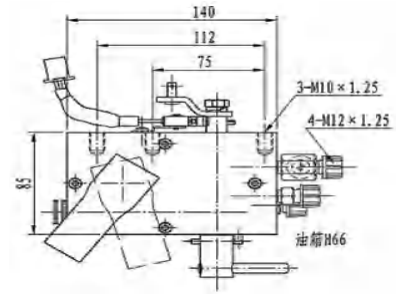

SORL NO. 5003 316 181 0

DESCRIPTION	FOR	OEM NO.
Electric Hydraulic Pump 电动泵	BALONG M7Q (5-hole) 柳汽霸龙M7Q(五孔)	M7Q-5002400B

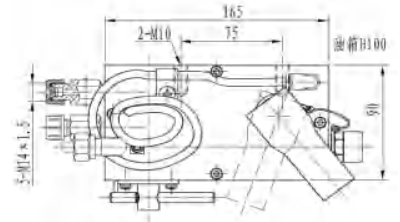

SORL NO. 5003 753 083 0

DESCRIPTION	FOR	OEM NO.
Electric Hydraulic Pump 电动泵	BALONG(e-pump) 柳汽霸龙(电动泵)	M5Q-5002500C

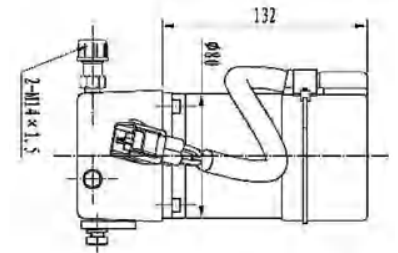

SORL NO. 5003 753 084 0

DESCRIPTION	FOR	OEM NO.
Electric Hydraulic Pump 电动泵	BALONG H7(e-pump) 柳汽霸龙H7(电动泵)	H73-5002500A

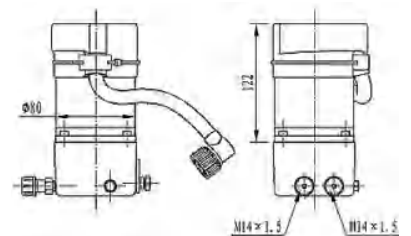

SORL NO. 5004 C10 001 0

DESCRIPTION	FOR	OEM NO.
Cabin Latch 液压锁	BALONG(right) 霸龙(右)	M5Q-5001240B M4Q-5001220B



SORL NO. 5004 C10 002 0

DESCRIPTION	FOR	OEM NO.
Cabin Latch 液压锁	BALONG(left) 霸龙(左)	M5Q-5001230B M4Q-5001230B

SERIES JAC 江淮系列

SORL NO. 5003 140 040 0



DESCRIPTION	FOR	OEM NO.
Cabin Cylinder 举升缸	GRFA 格尔发	64340-Y3070

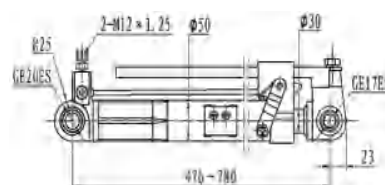

SORL NO. 5003 140 067 0



DESCRIPTION	FOR	OEM NO.
Cabin Cylinder 举升缸	GRFA 格尔发	64330-Y3B00XZ

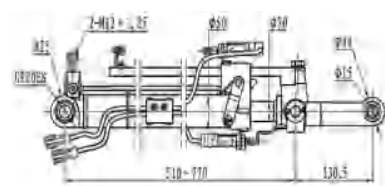

SORL NO. 5003 140 131 0



DESCRIPTION	FOR	OEM NO.
Cabin Cylinder 举升缸	GRFA 格尔发	64340-Y40D0XZ

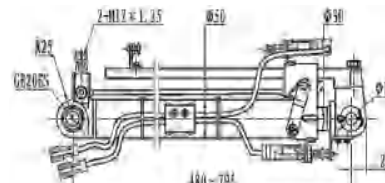

SORL NO. 5003 150 024 0



DESCRIPTION	FOR	OEM NO.
Cabin Cylinder 举升缸	JAC 江淮	5002030Y4T80

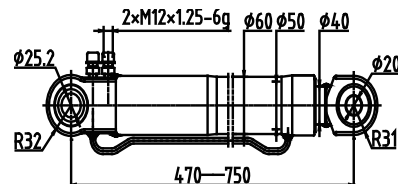

SORL NO. 5003 150 027 0



DESCRIPTION	FOR	OEM NO.
Cabin Cylinder 举升缸	GRFA 江淮格尔发	5002030-Y1J1Q

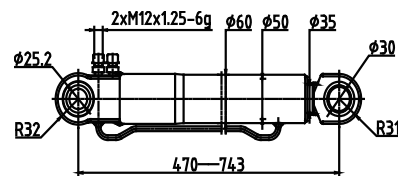



SORL NO. 5003 316 077 0

DESCRIPTION	FOR	OEM NO.
Hydraulic Cabin Pump 举升泵	GRFA 格尔发	64390-Y3070

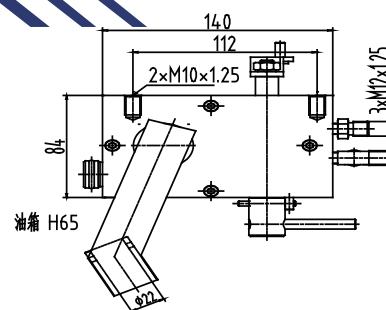

SORL NO. 5003 316 079 0

DESCRIPTION	FOR	OEM NO.
Hydraulic Cabin Pump 举升泵	GRFA (5-hole sensor) 格尔发 (五孔带传感器)	5004200H1010983

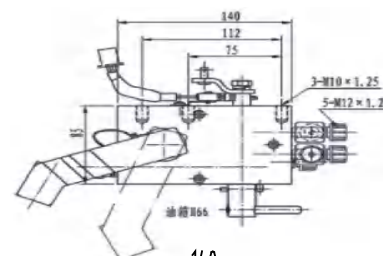

SORL NO. 5003 316 080 0

DESCRIPTION	FOR	OEM NO.
Hydraulic Cabin Pump 举升泵	GRFA (5-hole) 格尔发(五孔)	500-4200H1010

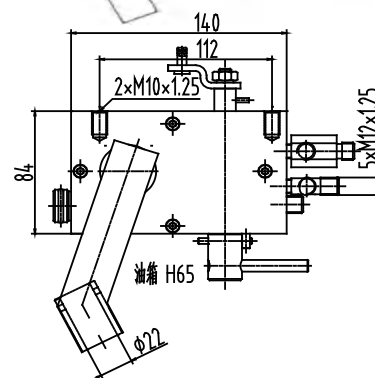

SORL NO. 5003 316 171 0

DESCRIPTION	FOR	OEM NO.
Hydraulic Cabin Pump 举升泵	GRFA (5-hole) 格尔发(五孔)	

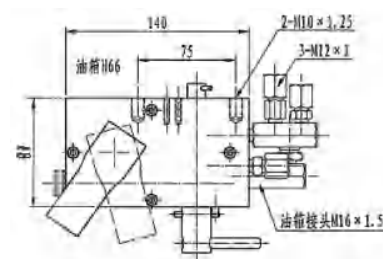

SORL NO. 5003 316 172 0

DESCRIPTION	FOR	OEM NO.
Hydraulic Cabin Pump 举升泵	GRFA (3-hole with lock) 格尔发(三孔带拉锁)	

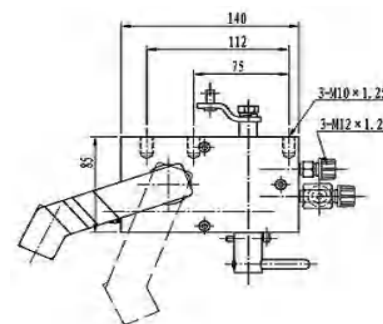

SORL NO. 5003 753 009 0

DESCRIPTION	FOR	OEM NO.
Electric Hydraulic Pump 电动泵	GRFA (e-pump) 格尔发(电动泵)	64391-Y4983

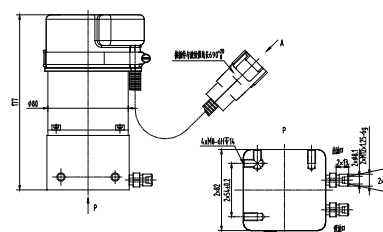



SORL NO. 5003 753 048 0

DESCRIPTION	FOR	OEM NO.
Electric Hydraulic Pump 电动泵	GRFA(combination) 格尔发(组合泵)	5004200H1010

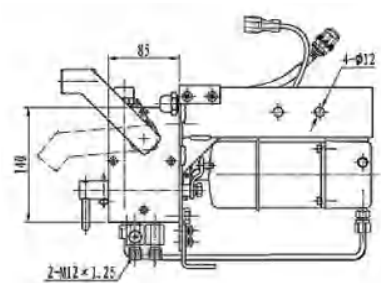

SORL NO. 5004 C7 001 0

DESCRIPTION	FOR	OEM NO.
Cabin Latch 液压锁	GRFA 格尔发	86970-73013



SORL NO. 5004 C7 003 0

DESCRIPTION	FOR	OEM NO.
Cabin Latch 液压锁	GRFA K7(left) 格尔发K7(左)	5004150Y8010



SORL NO. 5004 C7 004 0

DESCRIPTION	FOR	OEM NO.
Cabin Latch 液压锁	GRFA K7(right) 格尔发K7(右)	5004160Y8010



SORL NO. 5004 C7 005 0

DESCRIPTION	FOR	OEM NO.
Cabin Latch 液压锁	GRFA 格尔发	86970-Y3B00

SERIES SHACMAN 陕汽系列

SORL NO. 5003 140 025 0



DESCRIPTION	FOR	OEM NO.
Cabin Cylinder 举升缸	DELONG(F2000) 德龙老款 F2000	DZ1640820020

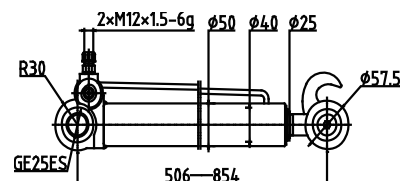

SORL NO. 5003 140 026 0



DESCRIPTION	FOR	OEM NO.
Cabin Cylinder 举升缸	DELONG(EURO 3) 德龙欧3	DZ93259820130

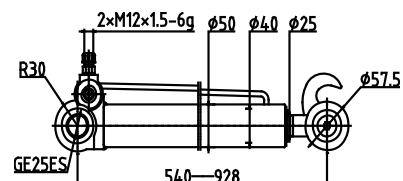

SORL NO. 5003 140 027 0



DESCRIPTION	FOR	OEM NO.
Cabin Cylinder 举升缸	DELONG(EURO 3) 德龙欧3	DZ93259820131

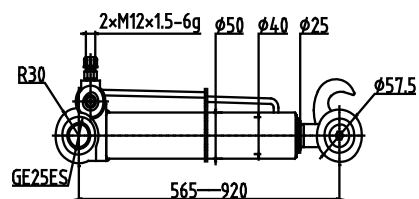

SORL NO. 5003 140 028 0



DESCRIPTION	FOR	OEM NO.
Cabin Cylinder 举升缸	DELONG(EURO 3) 德龙欧3	DZ93259820132

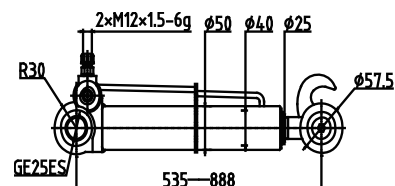

SORL NO. 5003 140 029 0



DESCRIPTION	FOR	OEM NO.
Cabin Cylinder 举升缸	DELONG(EURO 3) 德龙欧3	DZ93259820120

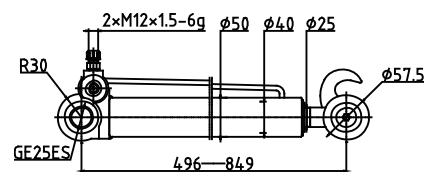

SORL NO. 5003 140 030 0



DESCRIPTION	FOR	OEM NO.
Cabin Cylinder 举升缸	DELONG(EURO 3) 德龙欧3	DZ93259820160

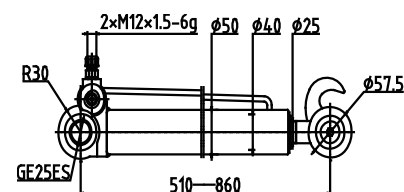

SORL NO. 5003 140 031 0



DESCRIPTION	FOR	OEM NO.
Cabin Cylinder 举升缸	DELONG(EURO 3) 德龙欧3	DZ1640820060

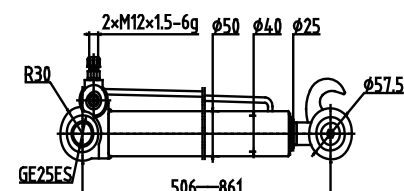

SORL NO. 5003 140 043 0



DESCRIPTION	FOR	OEM NO.
Cabin Cylinder 举升缸	DELONG(EURO 3) 德龙欧3	DZ1643820030

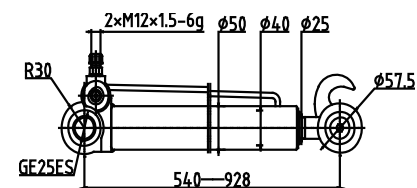

SORL NO. 5003 140 044 0



DESCRIPTION	FOR	OEM NO.
Cabin Cylinder 举升缸	DELONG(EURO 3) 德龙欧3	DZ1643820031

SORL NO. 5003 140 051 0



DESCRIPTION	FOR	OEM NO.
Cabin Cylinder 举升缸	DELONG 德龙	DZ1643820032

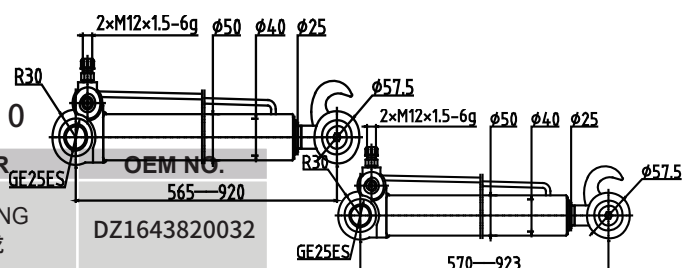

SORL NO. 5003 140 054 0



DESCRIPTION	FOR	OEM NO.
Cabin Cylinder 举升缸	DELONG M3000 德龙M3000	DZ93259820105

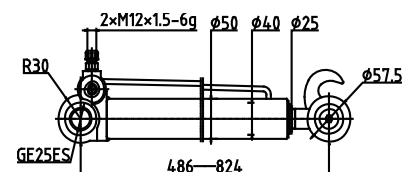

SORL NO. 5003 140 126 0



DESCRIPTION	FOR	OEM NO.
Cabin Cylinder 举升缸	DELOGN MINER 德龙矿车	DZ1649820019

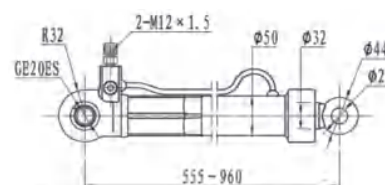

SORL NO. 5003 140 127 0



DESCRIPTION	FOR	OEM NO.
Cabin Cylinder 举升缸	AOLONG 奥龙	DZ9100820029

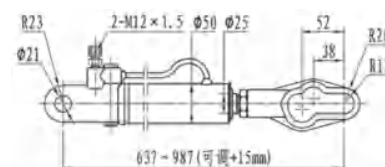

SORL NO. 5003 140 128 0



DESCRIPTION	FOR	OEM NO.
Cabin Cylinder 举升缸	DELONG(EURO 3) 德龙欧3	DZ93259820032

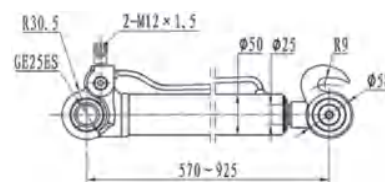

SORL NO. 5003 140 129 0



DESCRIPTION	FOR	OEM NO.
Cabin Cylinder 举升缸	DELONG(EURO 3) 德龙欧3	SZ182000788

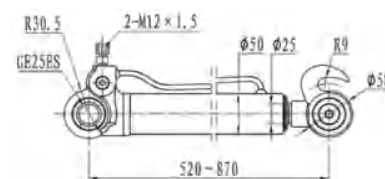

SORL NO. 5003 140 130 0



DESCRIPTION	FOR	OEM NO.
Cabin Cylinder 举升缸	DELONG X3000 德龙X3000	DZ96259820300

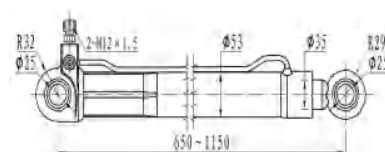

SORL NO. 5003 140 225 0



DESCRIPTION	FOR	OEM NO.
Cabin Cylinder 举升缸	SHACMAN 陕汽	SG-H40X3335-00A

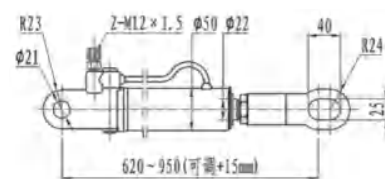

SORL NO. 5003 150 018 0



DESCRIPTION	FOR	OEM NO.
Cabin Cylinder 举升缸	DELONG X3000 德龙X3000	DZ97259820101

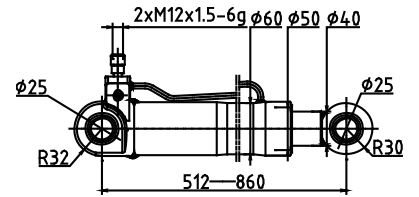

SORL NO. 5003 150 019 0



DESCRIPTION	FOR	OEM NO.
Cabin Cylinder 举升缸	DELONG X3000 德龙X3000	DZ97259820102

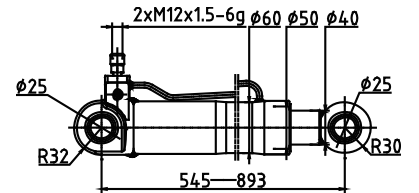

SORL NO. 5003 150 025 0



DESCRIPTION	FOR	OEM NO.
Cabin Cylinder 举升缸	DELONG X3000 德龙X3000	DZ97259820103

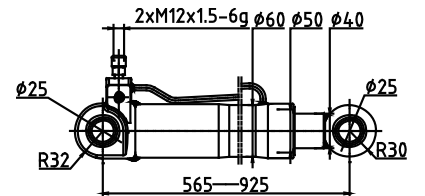

SORL NO. 5003 150 038 0



DESCRIPTION	FOR	OEM NO.
Cabin Cylinder 举升缸	DELONG X3000 德龙X3000	DZ97259820104

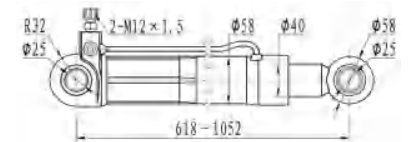

SORL NO. 5003 316 060 0



DESCRIPTION	FOR	OEM NO.
Hydraulic Cabin Pump 举升泵	DELONG X3000 德龙X3000	DZ93259820100

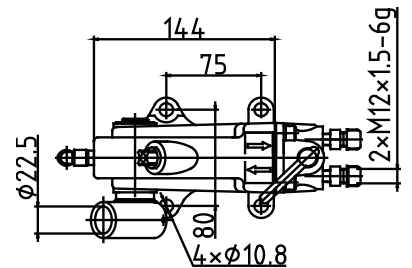

SORL NO. 5003 316 064 0



DESCRIPTION	FOR	OEM NO.
Hydraulic Cabin Pump 举升泵	DELONG 德龙	DZ9100820027

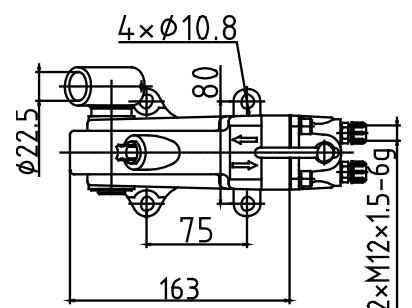



SORL NO. 5003 316 073 0

DESCRIPTION	FOR	OEM NO.
Hydraulic Cabin Pump 举升泵	DELONG X3000 (4-hole) 德龙X3000(四孔)	DZ97259820127

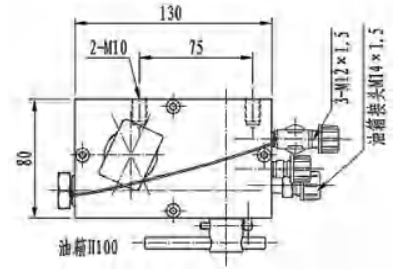

SORL NO. 5003 316 117 0

DESCRIPTION	FOR	OEM NO.
Hydraulic Cabin Pump 举升泵	SHACMAN 陕汽	DZ97259820153

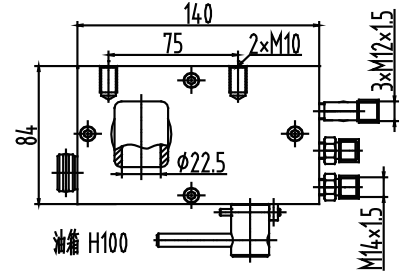

SORL NO. 5003 316 169 0

DESCRIPTION	FOR	OEM NO.
Hydraulic Cabin Pump 举升泵	DELONG (single oil way) 德龙(单油路)	DZ93259820400

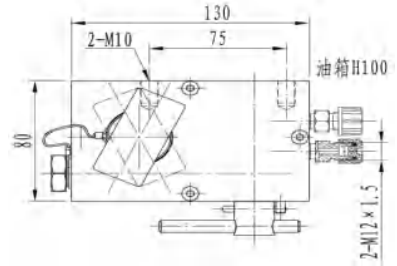

SORL NO. 5003 316 170 0

DESCRIPTION	FOR	OEM NO.
Hydraulic Cabin Pump 举升泵	DELONG X3000 (2-hole) 德龙X3000(二孔)	DZ97259820125

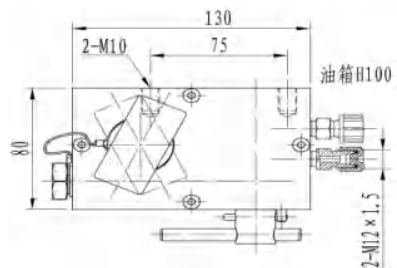

SORL NO. 5003 753 016 0

DESCRIPTION	FOR	OEM NO.
Electric Hydraulic Pump 电动泵	DELONG X3000 (e-pump) 德龙X3000(电动泵)	DZ97259820128

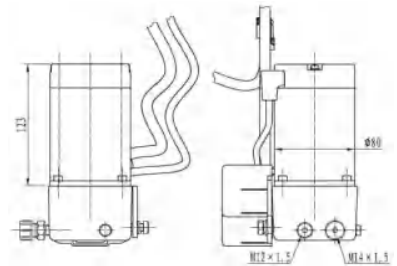

SORL NO. 5003 753 087 0

DESCRIPTION	FOR	OEM NO.
Electric Hydraulic Pump 电动泵	DELONG X3000 (e-pump) 德龙X3000(电动泵)	DZ97259820140

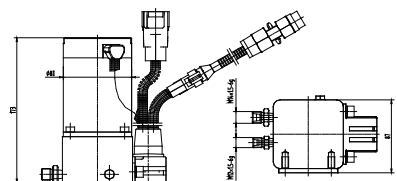



SORL NO. 5003 753 017 0

DESCRIPTION	FOR	OEM NO.
Hydraulic Cabin Pump 举升泵	DELONG(combination) 德龙(组合泵)	DZ1649820020

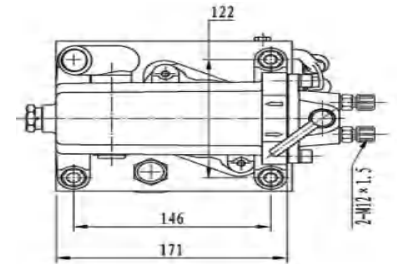

SORL NO. 5003 753 020 0

DESCRIPTION	FOR	OEM NO.
Hydraulic Cabin Pump 举升泵	DELONG (automatic & manual) 德龙(手自一体泵)	DZ93259820200

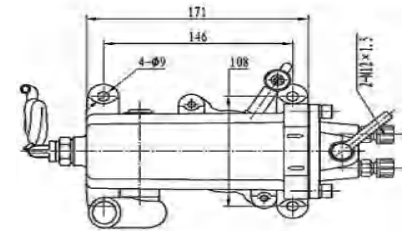

SORL NO. 5003 753 047 0

DESCRIPTION	FOR	OEM NO.
Hydraulic Cabin Pump 举升泵	DELONG (automatic & manual) 德龙(手自一体泵)	DZ93259820020

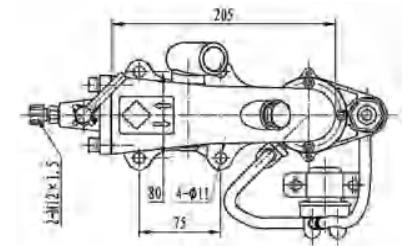

SORL NO. 5003 753 080 0

DESCRIPTION	FOR	OEM NO.
Hydraulic Cabin Pump 举升泵	DELONG (automatic & manual) 德龙(手自一体泵)	DZ93259820028

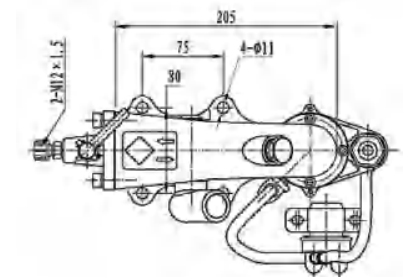

SORL NO. 5003 753 081 0

DESCRIPTION	FOR	OEM NO.
Hydraulic Cabin Pump 举升泵	DELONG (automatic & manual) 德龙(手自一体泵)	DZ93259820060

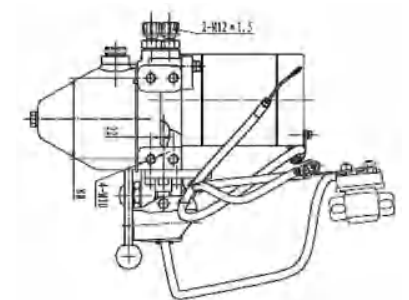

SORL NO. 5004 C4 001 0

DESCRIPTION	FOR	OEM NO.
Cabin Latch 液压锁	DELONG (plate thickness 2.5) 德龙(板厚2.5)	81618516020

**SORL NO. 5004 C4 001 0-1**

DESCRIPTION	FOR	OEM NO.
Cabin Latch 液压锁	DELONG (plate thickness 3) 德龙(板厚3)	81618516020

**SORL NO. 5004 C4 002 0**

DESCRIPTION	FOR	OEM NO.
Cabin Latch 液压锁	DELONG (plate thickness 2.5) 新德龙(板厚2.5)	81618516020

**SORL NO. 5004 C4 002 0-1**

DESCRIPTION	FOR	OEM NO.
Cabin Latch 液压锁	DELONG (plate thickness 3) 新德龙(板厚3)	81618516020

**SORL NO. 5004 C4 003 0**

DESCRIPTION	FOR	OEM NO.
Cabin Latch 液压锁	AOLONG (hydrocylinder) 奥龙(油缸)	DZ1600440065

**SORL NO. 5004 C4 004 0**

DESCRIPTION	FOR	OEM NO.
Cabin Latch 液压锁	DELONG M3000(left) 德龙M3000(左)	DZ13241440090

**SORL NO. 5004 C4 005 0**

DESCRIPTION	FOR	OEM NO.
Cabin Latch 液压锁	DELONG M3000(right) 德龙M3000(右)	DZ13241440085



SORL NO. 5004 C4 006 0

DESCRIPTION	FOR	OEM NO.
Cabin Latch 液压锁	DELONG 德龙	81618516023

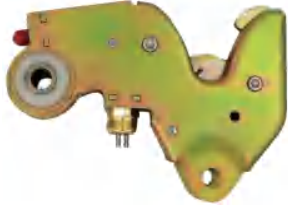

SORL NO. 5004 C4 007 0

DESCRIPTION	FOR	OEM NO.
Cabin Latch 液压锁	Delong double layer 德龙双层	FSZ144000756



SORL NO. 5004 C4 008 0

DESCRIPTION	FOR	OEM NO.
Cabin Latch 液压锁	Delong (Double layer thickening) 德龙(双层加厚)	SZ144000756

SERIES BEIBEN 北奔系列



SORL NO. 5003 140 015 0

DESCRIPTION	FOR	OEM NO.
Cabin Cylinder 举升缸	BEIBEN(long) 奔驰(长缸)	25363128

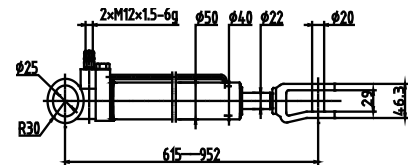

SORL NO. 5003 140 017 0

DESCRIPTION	FOR	OEM NO.
Cabin Cylinder 举升缸	BEIBEN(EURO 3) 奔驰欧3	0015532505

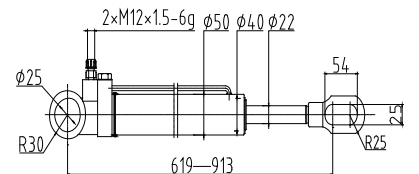

SORL NO. 5003 140 018 0



DESCRIPTION	FOR	OEM NO.
Cabin Cylinder 举升缸	BEIBEN(short) 奔驰(短缸)	0015533505

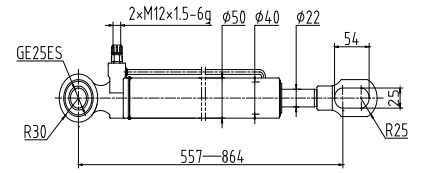

SORL NO. 5003 140 019 0



DESCRIPTION	FOR	OEM NO.
Cabin Cylinder 举升缸	BEIBEN(long) 奔驰长缸	0015534205

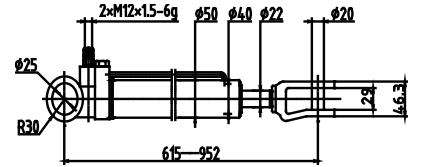

SORL NO. 5003 140 020 0



DESCRIPTION	FOR	OEM NO.
Cabin Cylinder 举升缸	BEIBEN(EURO 3) 奔驰欧3	0015534305

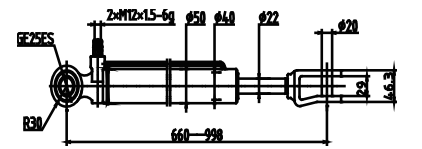

SORL NO. 5003 140 021 0



DESCRIPTION	FOR	OEM NO.
Cabin Cylinder 举升缸	BEIBEN(EURO 3) 奔驰欧3	5025530205

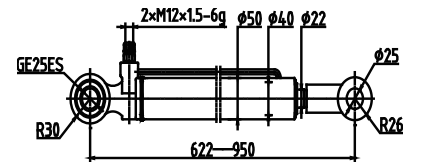

SORL NO. 5003 140 022 0



DESCRIPTION	FOR	OEM NO.
Cabin Cylinder 举升缸	BEIBEN(EURO 3) 奔驰欧3	5205530405

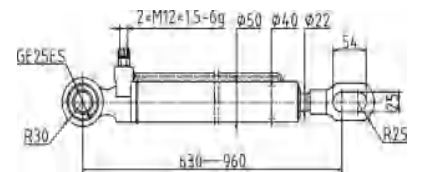

SORL NO. 5003 140 023 0



DESCRIPTION	FOR	OEM NO.
Cabin Cylinder 举升缸	BEIBEN(EURO 3) 奔驰欧3	5205530505

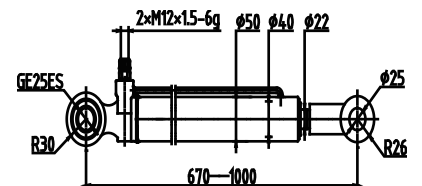

SORL NO. 5003 140 024 0



DESCRIPTION	FOR	OEM NO.
Cabin Cylinder 举升缸	BEIBEN(EURO 3) 奔驰欧3	5025534305

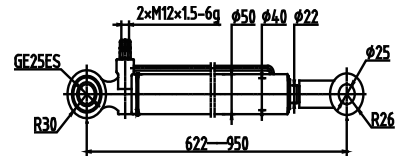

SORL NO. 5003 140 068 0



DESCRIPTION	FOR	OEM NO.
Cabin Cylinder 举升缸	BEIBEN V3 奔驰V3	5185530205

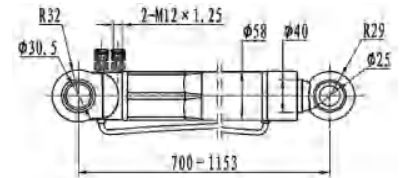

SORL NO. 5003 140 074 0



DESCRIPTION	FOR	OEM NO.
Cabin Cylinder 举升缸	BEIBEN(EURO 3) 奔驰欧3	5025534205

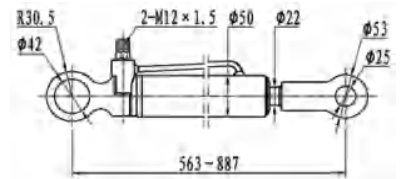

SORL NO. 5003 140 075 0



DESCRIPTION	FOR	OEM NO.
Cabin Cylinder 举升缸	BEIBEN 奔驰	8185530505

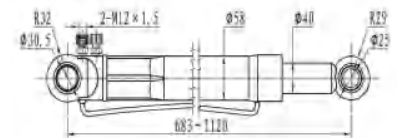

SORL NO. 5003 140 076 0



DESCRIPTION	FOR	OEM NO.
Cabin Cylinder 举升缸	BEIBEN 奔驰	1285530705

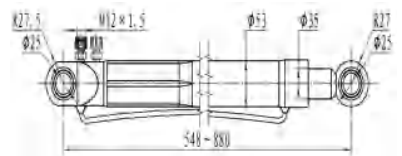

SORL NO. 5003 140 077 0



DESCRIPTION	FOR	OEM NO.
Cabin Cylinder 举升缸	BEIBEN 奔驰	1285530405

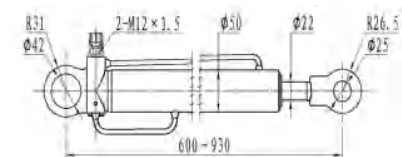

SORL NO. 5003 140 078 0



DESCRIPTION	FOR	OEM NO.
Cabin Cylinder 举升缸	BEIBEN 奔驰	4195530605

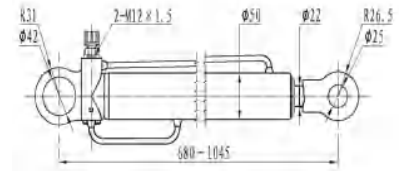

SORL NO. 5003 140 218 0



DESCRIPTION	FOR	OEM NO.
Cabin Cylinder 举升缸	BEIBEN(EURO 3) 奔驰欧3	206553505

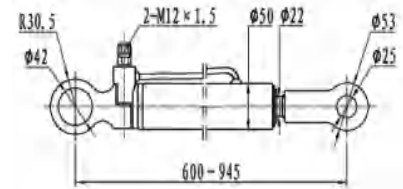

SORL NO. 5003 316 045 0



DESCRIPTION	FOR	OEM NO.
Hydraulic Cabin Pump 举升泵	HANIA 奔驰(短架)	0005537901

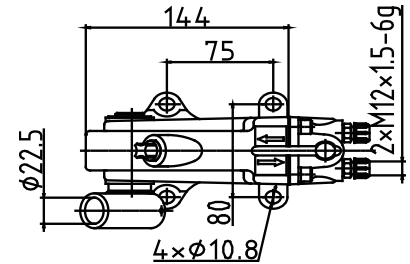

SORL NO. 5003 316 046 0



DESCRIPTION	FOR	OEM NO.
Hydraulic Cabin Pump 举升泵	BEIBEN (long bracket) 奔驰(长架)	

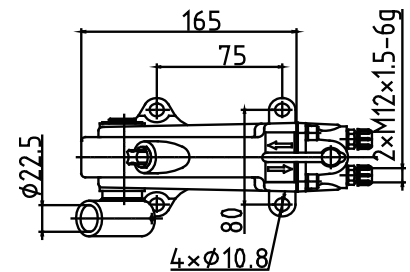

SORL NO. 5003 316 087 0



DESCRIPTION	FOR	OEM NO.
Hydraulic Cabin Pump 举升泵	BEIBEN 北方奔驰	9855530101

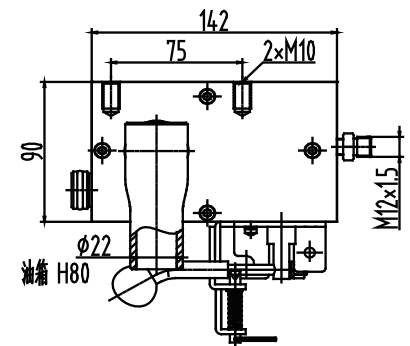

SORL NO. 5003 316 118 0



DESCRIPTION	FOR	OEM NO.
Hydraulic Cabin Pump 举升泵	V3(3-hole) 奔驰V3(三孔)	5185530101

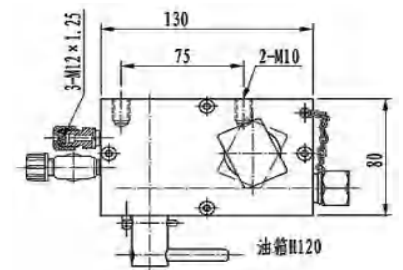



SORL NO. 5003 316 120 0

DESCRIPTION	FOR	OEM NO.
Hydraulic Cabin Pump 举升泵	V3(4-hole) 奔驰V3 (四孔)	5185530001

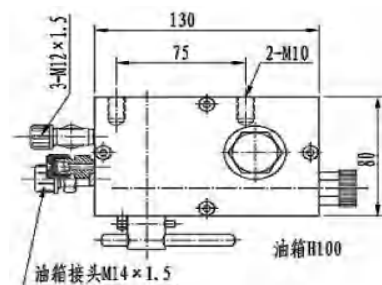

SORL NO. 5003 316 121 0

DESCRIPTION	FOR	OEM NO.
Hydraulic Cabin Pump 举升泵	BEIBEN 奔驰	8185530201

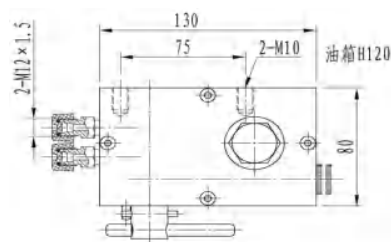

SORL NO. 5003 753 039 0

DESCRIPTION	FOR	OEM NO.
Electric Hydraulic Pump 电动泵	BEIBEN(e-pump) 奔驰(电动泵)	5185530201

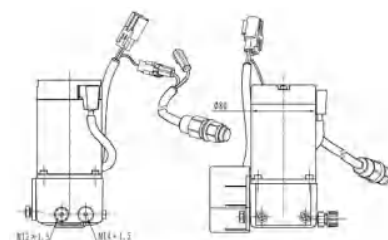

SORL NO. 5004 C6 004 0

DESCRIPTION	FOR	OEM NO.
Cabin Latch 液压锁	Beifangguo Mercedse-Benz (right) 北方国III奔驰(右)	Z01550224



SORL NO. 5004 C6 005 0

DESCRIPTION	FOR	OEM NO.
Cabin Latch 液压锁	Beifangguo Mercedse-Benz (left) 北方国III奔驰(左)	Z01550222



SORL NO. 5004 C6 006 0

DESCRIPTION	FOR	OEM NO.
Cabin Latch 液压锁	BEIBEN 北方奔驰	5208900068



SORL NO. 5004 C6 007 0

DESCRIPTION	FOR	OEM NO.
Cabin Latch 液压锁	BEIBEN 北方奔驰	1288910019



SORL NO. 5004 C6 008 0

DESCRIPTION	FOR	OEM NO.
Cabin Latch 液压锁	BEIBEN V3 (left) 北方奔驰V3(左)	5183170219



SORL NO. 5004 C6 009 0

DESCRIPTION	FOR	OEM NO.
Cabin Latch 液压锁	BEIBEN V3 (right) 北方奔驰V3(右)	5183170119



SORL NO. 5004 C6 010 0

DESCRIPTION	FOR	OEM NO.
Cabin Latch 液压锁	BEIBEN 奔驰	5183171116 00028814050034



SORL NO. 5004 C6 011 0

DESCRIPTION	FOR	OEM NO.
Cabin Latch 液压锁	BEIBEN(angle pipe) 奔驰(弯管)	5183171116 00028814050139

SERIES SANY 三一系列



SORL NO. 5003 140 114 0

DESCRIPTION	FOR	OEM NO.
Cabin Cylinder 举升缸	SANY 三一重工	50ZB1-03010B

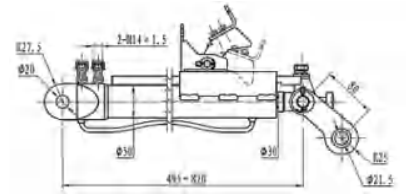

SORL NO. 5003 145 005 0

DESCRIPTION	FOR	OEM NO.
Cabin Cylinder 举升缸	东风三一车身	5002170-C0100B

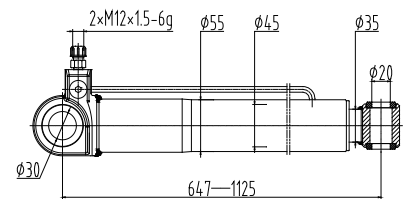

SORL NO. 5003 140 117 0

DESCRIPTION	FOR	OEM NO.
Cabin Cylinder 举升缸	SANY HUMAN 东风三一湖气	GC024

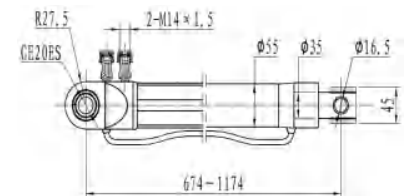

SORL NO. 5003 316 156 0

DESCRIPTION	FOR	OEM NO.
Hydraulic Cabin Pump 举升泵	SANY 三一重工	50ZP2-05010S

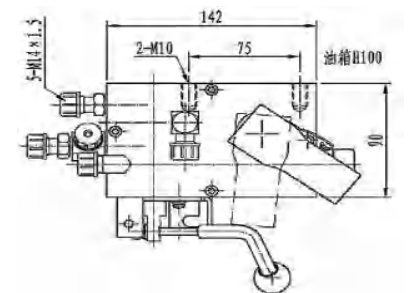

SORL NO. 5003 753 008 0

DESCRIPTION	FOR	OEM NO.
Electric Hydraulic Pump 电动泵	SANY (e-pump) 三一重工 (电动泵)	50ZP2-05010S

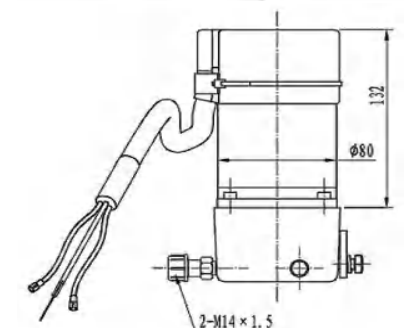



SURL NO. 5003 140 042 0

DESCRIPTION	FOR	OEM NO.
Cabin Cylinder 举升缸	KINGKONG NEW 红岩新金刚	5002-650020Y

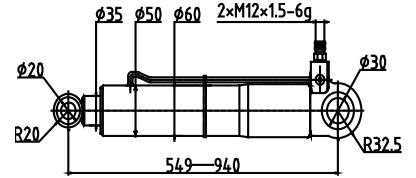

SURL NO. 5003 150 003 0

DESCRIPTION	FOR	OEM NO.
Cabin Cylinder 举升缸	GYNLYON 红岩杰狮	5002-500520Y

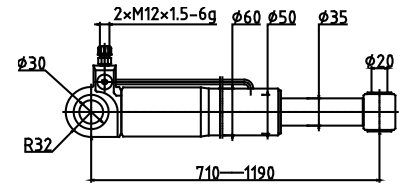

SURL NO. 5003 316 044 0

DESCRIPTION	FOR	OEM NO.
Hydraulic Cabin Pump 举升泵	GENLLYON;NEW 红岩杰狮 红岩新金刚	5002-500510Y

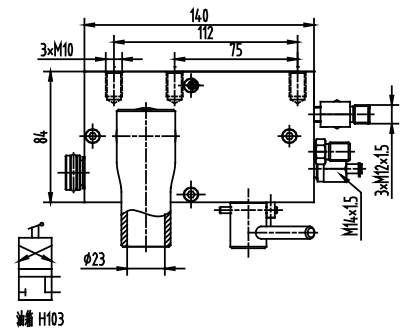

SURL NO. 5003 316 083 0

DESCRIPTION	FOR	OEM NO.
Hydraulic Cabin Pump 举升泵	KINGKONG(big) 红岩金刚(大)	5002-123050

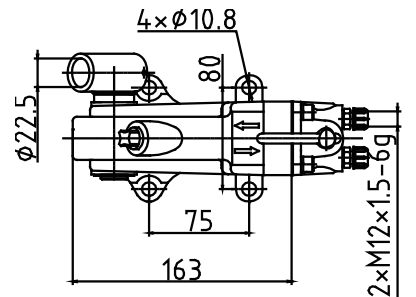

SURL NO. 5003 316 088 0

DESCRIPTION	FOR	OEM NO.
Hydraulic Cabin Pump 举升泵	HONGYAN 红岩	5002-500510

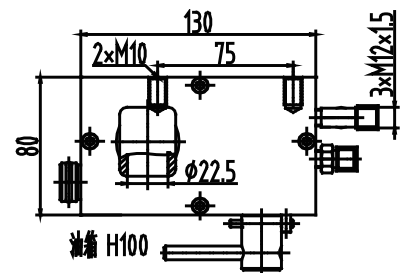

SURL NO. 5003 316 134 0

DESCRIPTION	FOR	OEM NO.
Hydraulic Cabin Pump 举升泵	GENLYON 红岩杰狮	5002-810110Y

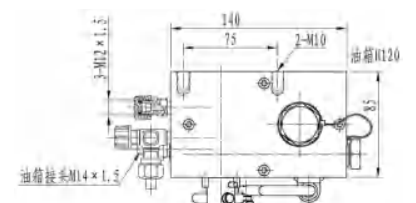



SORL NO. 5003 753 007 0

DESCRIPTION	FOR	OEM NO.
Electric Hydraulic Pump 电动泵	GENLYON(e-pump) 红岩杰狮(电动泵)	5002-500550

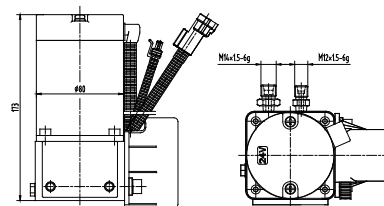

SORL NO. 5004 C9 001 0

DESCRIPTION	FOR	OEM NO.
Cabin Latch 液压锁	GENLYON (left) 红岩杰狮(左)	5004-500518 504088023



SORL NO. 5004 C9 002 0

DESCRIPTION	FOR	OEM NO.
Cabin Latch 液压锁	GENLYON (right) 红岩杰狮(右)	5004-500519 500353618

SERIES DAYUN 大运系列



SORL NO. 5003 140 090 0

DESCRIPTION	FOR	OEM NO.
Cabin Cylinder 举升缸	DAYUN HUBEI(main) 湖北大运(主缸)	5002010A0-1C522

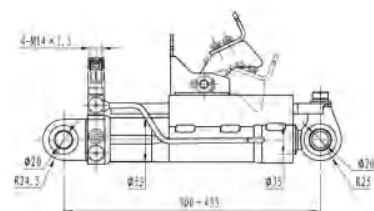

SORL NO. 5003 140 091 0

DESCRIPTION	FOR	OEM NO.
Cabin Cylinder 举升缸	DAYUN HUBEI(slave) 湖北大运(副缸)	5002020A0-1C522

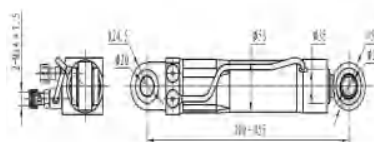



SORL NO. 5003 140 092 0

DESCRIPTION	FOR	OEM NO.
Cabin Cylinder 举升缸	DAYUN HUBEI (main small) 湖北大运(主缸)	5002020A0-N008

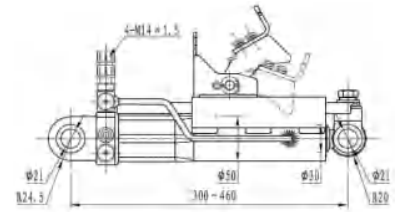

SORL NO. 5003 140 093 0

DESCRIPTION	FOR	OEM NO.
Cabin Cylinder 举升缸	DAYUN HUBEI (slave small) 湖北大运(副缸)	5002030A0-N008

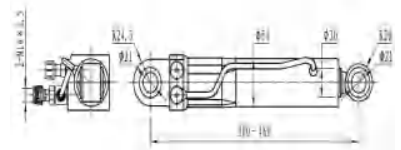

SORL NO. 5003 140 221 0

DESCRIPTION	FOR	OEM NO.
Cabin Cylinder 举升缸	DAYUN NEW 新大运	502JBB20000

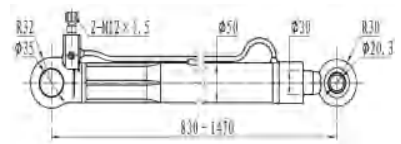

SORL NO. 5003 150 021 0

DESCRIPTION	FOR	OEM NO.
Cabin Cylinder 举升缸	DAYUN 大运	502AAA03000

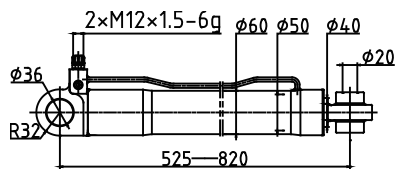

SORL NO. 5003 316 081 0

DESCRIPTION	FOR	OEM NO.
Hydraulic Cabin Pump 举升泵	DAYUN 大运	502AAA02000

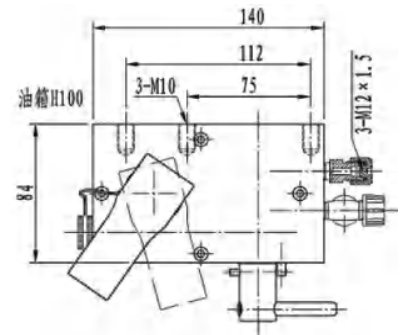

SORL NO. 5003 316 109 0

DESCRIPTION	FOR	OEM NO.
Hydraulic Cabin Pump 举升泵	DAYUN (5-pump) 大运(五孔)	502BAA00001

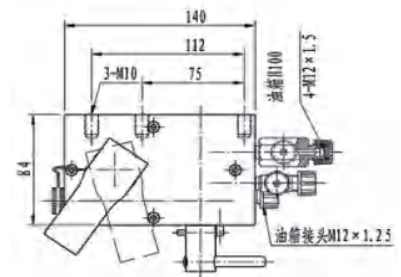



SORL NO. 5003 753 024 0

DESCRIPTION	FOR	OEM NO.
Hydraulic Cabin Pump 举升泵	DAYUN (combination) 大运(组合泵)	502BAA00001

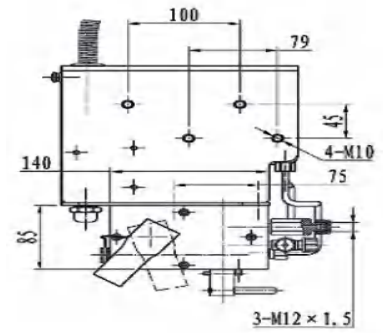

SORL NO. 5004 C12 001 0

DESCRIPTION	FOR	OEM NO.
Cabin Latch 液压锁	DAYUN NEW 新大运	501BBB03000



SORL NO. 5004 C12 002 0

DESCRIPTION	FOR	OEM NO.
Cabin Latch 液压锁	DAYUN NEW 新大运	501BAA03000



SORL NO. 5004 C12 003 0

DESCRIPTION	FOR	OEM NO.
Cabin Latch 液压锁	DAYUN (left) 大运重卡(左)	



SORL NO. 5004 C12 004 0

DESCRIPTION	FOR	OEM NO.
Cabin Latch 液压锁	DAYUN (right) 大运重卡(右)	

SERIES CMAC 华菱系列



SORL NO. 5003 136 016 0

DESCRIPTION	FOR	OEM NO.
Cabin Cylinder 举升缸	GENERATION 3 LH 华菱三代(左置)	5002A-010

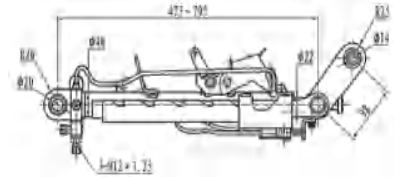

SORL NO. 5003 136 017 0

DESCRIPTION	FOR	OEM NO.
Cabin Cylinder 举升缸	CAMC 华菱	50A-08010-A

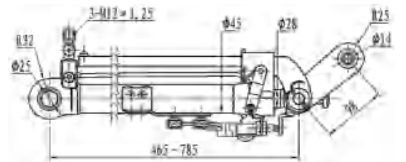

SORL NO. 5003 136 018 0

DESCRIPTION	FOR	OEM NO.
Cabin Cylinder 举升缸	GENERATION 3 (reverse) 华菱三代(反方向)	5002AY-010

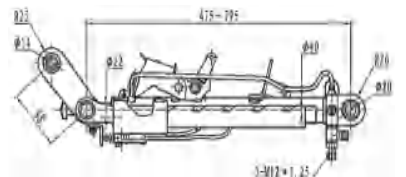

SORL NO. 5003 136 019 0

DESCRIPTION	FOR	OEM NO.
Cabin Cylinder 举升缸	CAMC LH 华菱(左置)	5002M-010

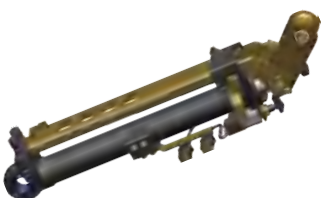
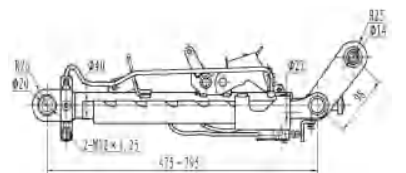

SORL NO. 5003 136 020 0

DESCRIPTION	FOR	OEM NO.
Cabin Cylinder 举升缸	CAMC 华菱	50M-08010

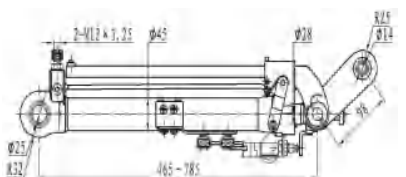



SORL NO. 5003 140 132 0

DESCRIPTION	FOR	OEM NO.
Cabin Cylinder 举升缸	GENERATION 2 华菱二代	5002A-010-A

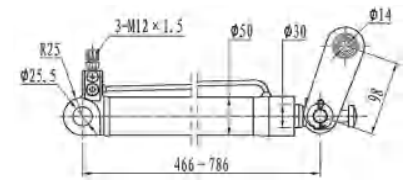

SORL NO. 5003 140 133 0

DESCRIPTION	FOR	OEM NO.
Cabin Cylinder 举升缸	GENERATION 4 华菱四代	50A-09010

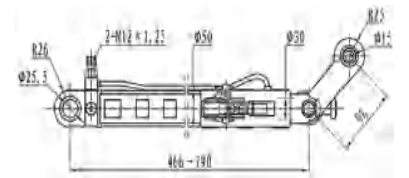

SORL NO. 5003 140 134 0

DESCRIPTION	FOR	OEM NO.
Cabin Cylinder 举升缸	GENERATION 1 华菱一代	50A-07010

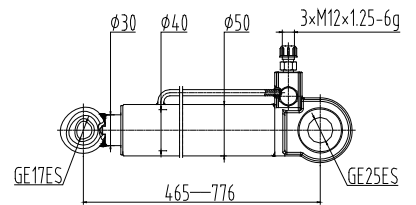

SORL NO. 5003 150 026 0

DESCRIPTION	FOR	OEM NO.
Cabin Cylinder 举升缸	XINKAIMA 新凯马	50H08-02030

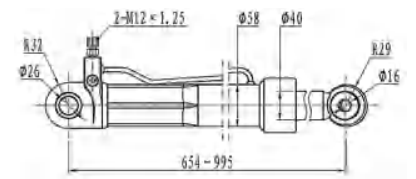

SORL NO. 5003 316 027 0

DESCRIPTION	FOR	OEM NO.
Hydraulic Cabin Pump 举升泵	CAMC(3-hole) 华菱(三孔)	

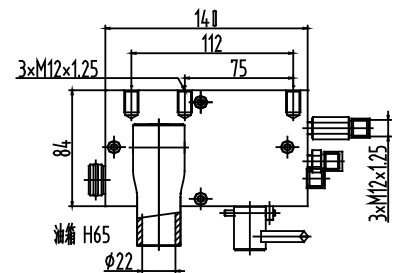

SORL NO. 5003 316 174 0

DESCRIPTION	FOR	OEM NO.
Cabin Cylinder 举升缸	CAMC(4-hole) 华菱(四孔)	50A-07035

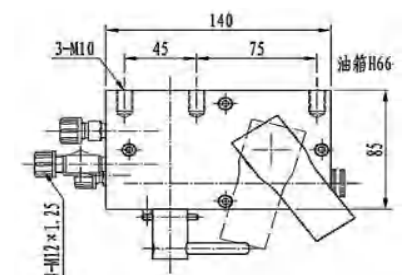



SORL NO. 5003 316 175 0

DESCRIPTION	FOR	OEM NO.
Cabin Cylinder 举升缸	CAMC(4-hole) 华菱(四孔)	50A3D-07035

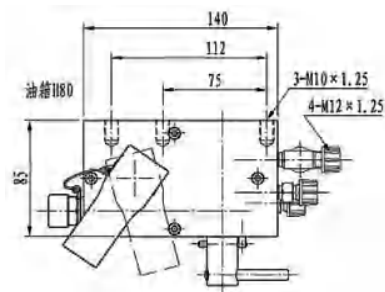

SORL NO. 5003 316 176 0

DESCRIPTION	FOR	OEM NO.
Cabin Cylinder 举升缸	CAMC(4-hole) 华菱(四孔)	50A5-08035

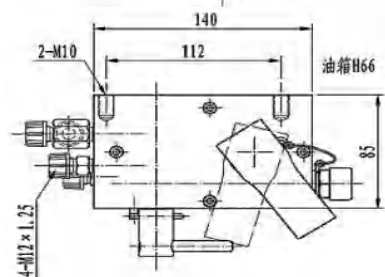

SORL NO. 5003 316 177 0

DESCRIPTION	FOR	OEM NO.
Cabin Cylinder 举升缸	CAMC(5-hole) 华菱(五孔)	50H6-08035

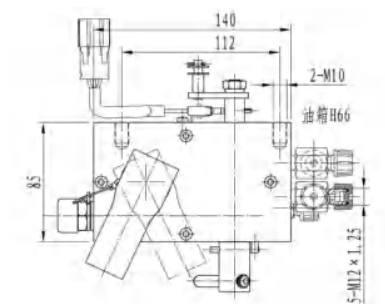

SORL NO. 5003 316 178 0

DESCRIPTION	FOR	OEM NO.
Cabin Cylinder 举升缸	CAMC(5-hole) 华菱(五孔)	50M-08035

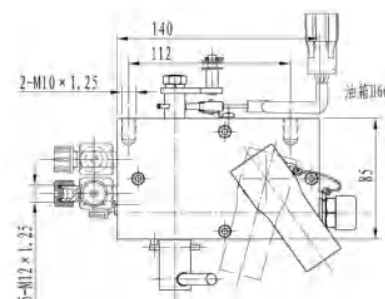

SORL NO. 5003 753 003 0

DESCRIPTION	FOR	OEM NO.
Electric Hydraulic Pump 电动泵	CAMC(e-pump) 华菱(电动泵)	50A3D-07035

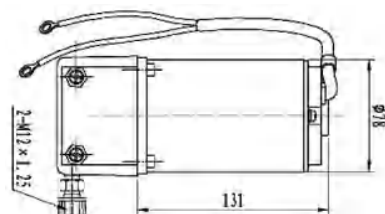

SORL NO. 5003 753 013 0

DESCRIPTION	FOR	OEM NO.
Hydraulic Cabin Pump 举升泵	XINKAIMA (automatic & manual) 华菱新凯马(手自一体泵)	50H08-02050

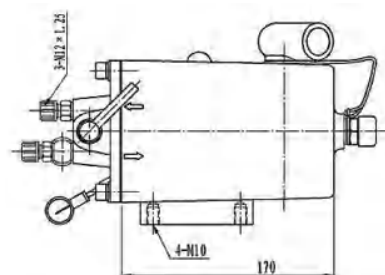



SORL NO. 5003 753 014 0

DESCRIPTION	FOR	OEM NO.
Hydraulic Cabin Pump 举升泵	CAMC (automatic & manual) 华菱(手自一体泵)	5004A-020

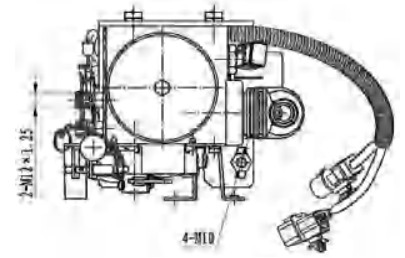

SORL NO. 5003 753 034 0

DESCRIPTION	FOR	OEM NO.
Hydraulic Cabin Pump 举升泵	CAMC (automatic) 华菱(组合泵)	50A3D-07035

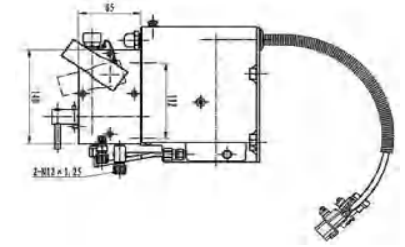

SORL NO. 5003 753 051 0

DESCRIPTION	FOR	OEM NO.
Hydraulic Cabin Pump 举升泵	CAMC(reverse) 华菱反方向 (手自一体泵)	5004A5-020-A

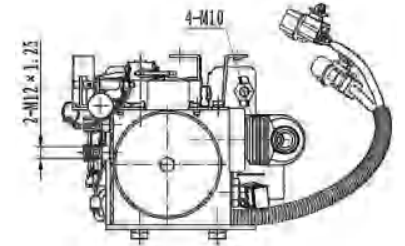

SORL NO. 5003 753 052 0

DESCRIPTION	FOR	OEM NO.
Hydraulic Cabin Pump 举升泵	CAMC(reverse combination) 华菱反方向(组合泵)	50A5-08035

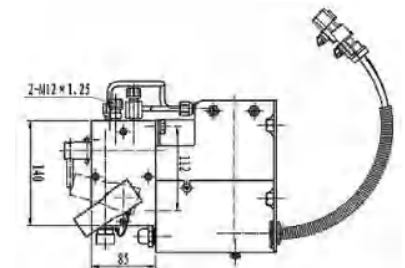

SORL NO. 5003 753 053 0

DESCRIPTION	FOR	OEM NO.
Hydraulic Cabin Pump 举升泵	CAMC (automatic & reverse) 华菱(手自一体泵)	500H6-06020

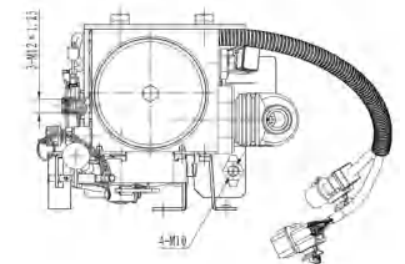

SORL NO. 5003 753 054 0

DESCRIPTION	FOR	OEM NO.
Hydraulic Cabin Pump 举升泵	CAMC9 (automatic & reverse) 华菱反方向(手自一体泵)	5004M-020

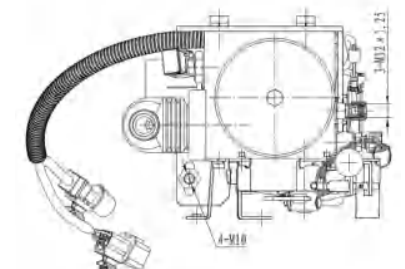



SORL NO. 5003 753 055 0

DESCRIPTION	FOR	OEM NO.
Hydraulic Cabin Pump 举升泵	CAMC(combination) 华菱(组合泵)	50H6-08035

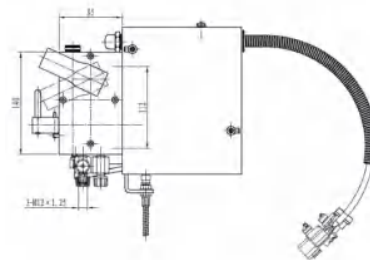

SORL NO. 5003 753 056 0

DESCRIPTION	FOR	OEM NO.
Hydraulic Cabin Pump 举升泵	CAMC (reverse) 华菱反方向(组合泵)	50M-08035

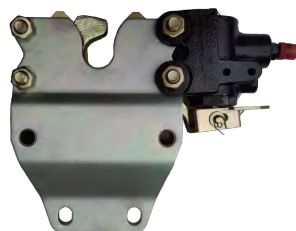
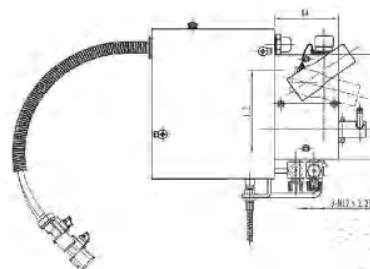

SORL NO. 5004 C8 002 0

DESCRIPTION	FOR	OEM NO.
Cabin Latch 液压锁	CAMC 华菱	5004A010

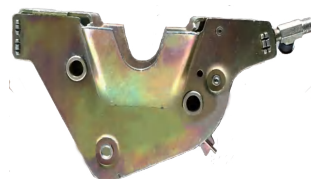

SORL NO. 5004 C8 003 0

DESCRIPTION	FOR	OEM NO.
Cabin Latch 液压锁	CAMC 华菱	



SORL NO. 5004 C8 004 0

DESCRIPTION	FOR	OEM NO.
Cabin Latch 液压锁	CAMC HANMA 华菱悍马	



SORL NO. 5004 C8 005 0

DESCRIPTION	FOR	OEM NO.
Cabin Latch 液压锁	XINGKAIMA 星凯马	



SORL NO. 5004 C8 006 0

DESCRIPTION	FOR	OEM NO.
Cabin Latch 液压锁	XINGKAIMA(right) 星凯马(右)	50H08-01138 7005513040082



SORL NO. 5004 C8 007 0

DESCRIPTION	FOR	OEM NO.
Cabin Latch 液压锁	XINGKAIMA(left) 星凯马(左)	50H08-01137 7005513090127

SERIES XCMG 徐工系列



SORL NO. 5003 136 026 0

DESCRIPTION	FOR	OEM NO.
Cabin Cylinder 举升缸	XCMG 徐工	NCL50T108-03310

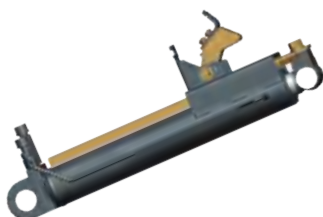
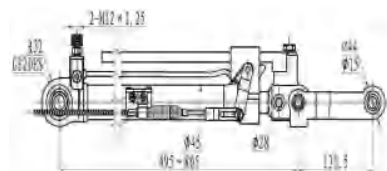

SORL NO. 5003 140 096 0

DESCRIPTION	FOR	OEM NO.
Cabin Cylinder 举升缸	XCMG 徐工	NXG50KFW735-02310

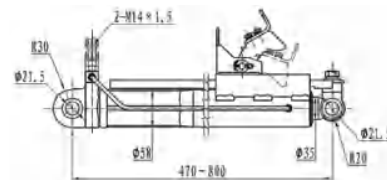

SORL NO. 5003 140 138 0

DESCRIPTION	FOR	OEM NO.
Cabin Cylinder 举升缸	XCMG 徐工	NXG50TFW111-02310

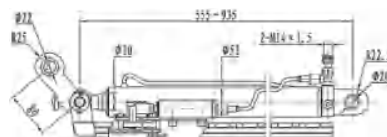



SORL NO. 5003 316 184 0

DESCRIPTION	FOR	OEM NO.
Hydraulic Cabin Pump 举升泵	XCMG(3-hole) 徐工(三孔)	NXG50TFW111-02340

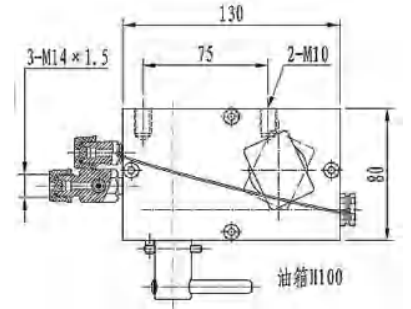

SORL NO. 5003 316 186 0

DESCRIPTION	FOR	OEM NO.
Hydraulic Cabin Pump 举升泵	XCMG(5-hole) 徐工(五孔)	NXG50WLAM111-02340

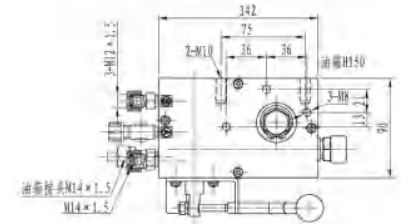

SORL NO. 5004 C13 001 0

DESCRIPTION	FOR	OEM NO.
Cabin Latch 液压锁	XCMG HANFENG 徐工汉风	



SORL NO. 5004 C13 002 0

DESCRIPTION	FOR	OEM NO.
Cabin Latch 液压锁	XCMG QILONG 徐工祺龙重卡	

SERIES C&C 联合卡车系列



SORL NO. 5003 140 139 0

DESCRIPTION	FOR	OEM NO.
Cabin Cylinder 举升缸	C&C 联合重卡	100450800019AC0A

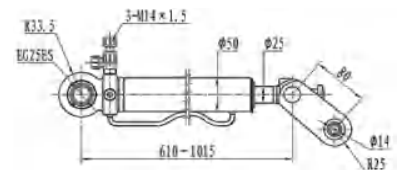



SORL NO. 5003 140 145 0

DESCRIPTION	FOR	OEM NO.
Cabin Cylinder 举升缸	C&C 联合重卡	100450800249

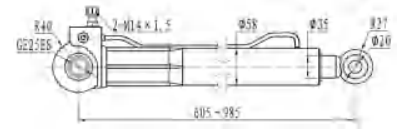

SORL NO. 5003 316 185 0

DESCRIPTION	FOR	OEM NO.
Hydraulic Cabin Pump 举升泵	C&C 联合重卡	100450800014

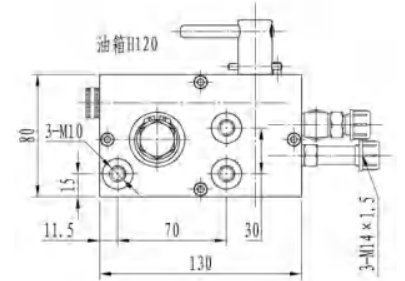

SORL NO. 5003 753 012 0

DESCRIPTION	FOR	OEM NO.
Electric Hydraulic Pump 电动泵	C&C (automatic & manual) 联合重卡(手自一体泵)	100450800118

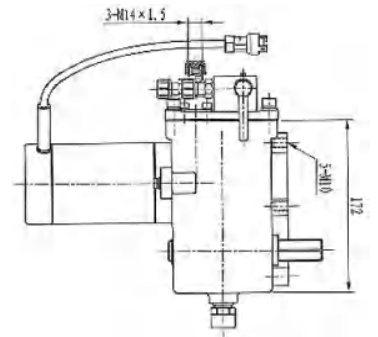

SORL NO. 5004 C14 001 0

DESCRIPTION	FOR	OEM NO.
Cabin Latch 液锁	C&C(left) 联合重卡(左)	150500400028



SORL NO. 5004 C14 002 0

DESCRIPTION	FOR	OEM NO.
Cabin Latch 液锁	C&C (right) 联合重卡(右)	150500400029

SERIES

OTHER BRANDS

其他品牌



SORL NO. 5003 132 006 0

DESCRIPTION	FOR	OEM NO.
Cabin Cylinder 举升缸	NANJUN 南骏	5002A00.83001

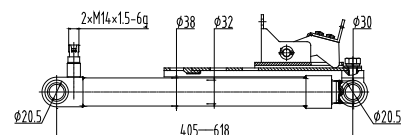

SORL NO. 5003 132 007 0

DESCRIPTION	FOR	OEM NO.
Cabin Cylinder 举升缸	NANJUN 南骏	5002A00.83002

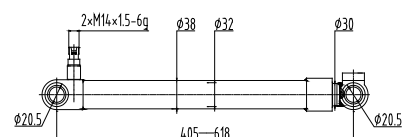

SORL NO. 5003 136 021 0

DESCRIPTION	FOR	OEM NO.
Cabin Cylinder 举升缸	HINO 700 广汽日野700	54960E0361

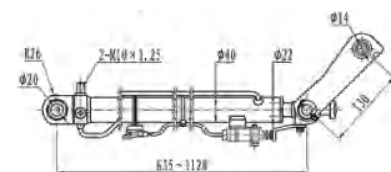

SORL NO. 5003 140 140 0

DESCRIPTION	FOR	OEM NO.
Cabin Cylinder 举升缸	XIELI SDLG 常州协力 临工	4120000183

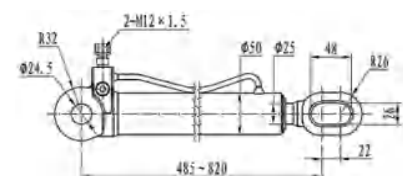

SORL NO. 5003 140 141 0

DESCRIPTION	FOR	OEM NO.
Cabin Cylinder 举升缸	FIRE TRUCK(single) 消防车(单缸)	

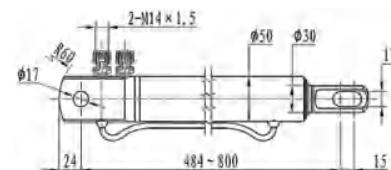



SORL NO. 5003 140 142 0

DESCRIPTION	FOR	OEM NO.
Cabin Cylinder 举升缸	FIRE TRUCK(main) 消防车(主缸)	

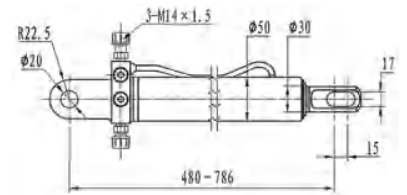

SORL NO. 5003 140 143 0

DESCRIPTION	FOR	OEM NO.
Cabin Cylinder 举升缸	FIRE TRUCK(slave) 消防车(副缸)	

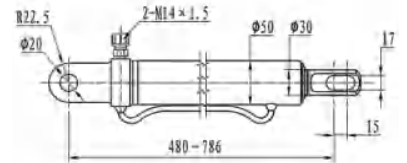

SORL NO. 5003 140 144 0

DESCRIPTION	FOR	OEM NO.
Cabin Cylinder 举升缸	SPACE TATE CYLINDR 航天泰特缸	3501B-RJ4041

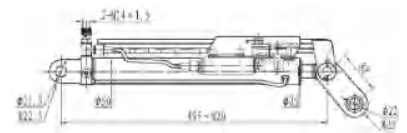

SORL NO. 5003 140 226 0

DESCRIPTION	FOR	OEM NO.
Cabin Cylinder 举升缸	FIRE TRUCK(main) 消防车新款(主缸)	

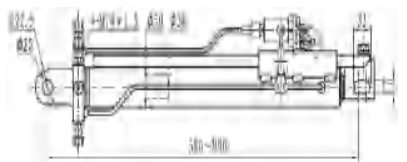

SORL NO. 5003 140 227 0

DESCRIPTION	FOR	OEM NO.
Cabin Cylinder 举升缸	FIRE TRUCK(slave) 消防车新款(副缸)	

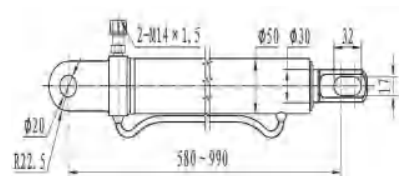

SORL NO. 5003 316 182 0

DESCRIPTION	FOR	OEM NO.
Hydraulic Cabin Pump 举升泵	HUIZHONG 汇重	

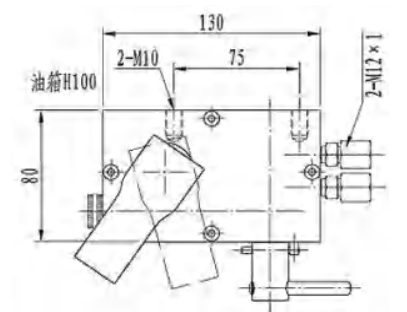

**SORL NO. 5003 316 183 0**

DESCRIPTION	FOR	OEM NO.
Electric Hydraulic Pump 电动泵	FIRE TRUCK 消防车	

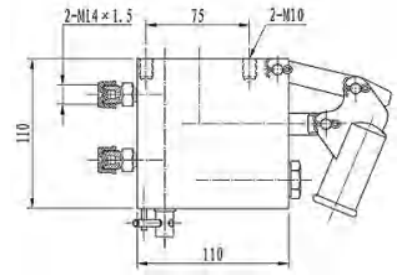
**SORL NO. 5003 316 187 0**

DESCRIPTION	FOR	OEM NO.
Electric Hydraulic Pump 电动泵	FIRE TRUCK(long) 消防车(加长型)	

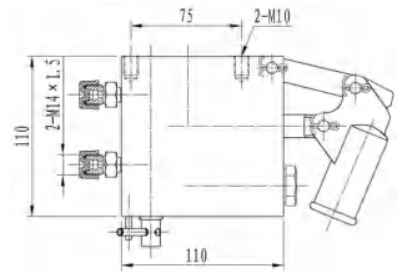
**SORL NO. 5003 316 188 0**

DESCRIPTION	FOR	OEM NO.
Hydraulic Cabin Pump 举升泵	SDLG 临工	LG9716827010

**SORL NO. 5003 316 269 0**

DESCRIPTION	FOR	OEM NO.
Hydraulic Cabin Pump 举升泵	FIRE TRUCK 消防车	

**SORL NO. 5003 316 270 0**

DESCRIPTION	FOR	OEM NO.
Hydraulic Cabin Pump 举升泵	SDLG 临工	

**SORL NO. 5004 C15 001 0**

DESCRIPTION	FOR	OEM NO.
Cabin Latch 液压锁	GUANGZHOU AUTOMOBILE HINO(left) 广汽日野(左)	

**SORL NO. 5004 C15 002 0**

DESCRIPTION	FOR	OEM NO.
Cabin Latch 液压锁	GUANGZHOU AUTOMABILE HINO(right) 广汽日野(右)	

**SORL NO. 5004 C15 003 0**

DESCRIPTION	FOR	OEM NO.
Cabin Latch 液压锁	MAN 曼	85618516003

**SORL NO. 5004 C15 004 0**

DESCRIPTION	FOR	OEM NO.
Cabin Latch 液压锁	MAN 依维柯	504125466

**SORL NO. 5004 C15 005 0**

DESCRIPTION	FOR	OEM NO.
Cabin Latch 液压锁	DAFU 达夫	

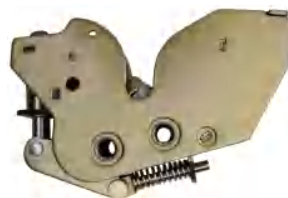
**SORL NO. 5004 C15 006 0**

DESCRIPTION	FOR	OEM NO.
Cabin Latch 液压锁	Scania 斯堪尼亚	



Headquarters

Ruili Group China

No.2666, KaiFaqu Avenue, Ruian Economic Development Zone, Zhejiang Province, 325200, China
Tel: 0086-577-6500 8000, 6560 9583
Fax: 0086-577-6592 2008
E-mail: info@sorl.com.cn
<http://www.sorl.com.cn>

Local distributor



Overseas branches

Global SORL Auto & Truck Parts Inc. (USA)

1200 E. Gene Autry Way
Anaheim CA 92805
Tel: 001-714-634 1888
Fax: 001-714-634 1886
E-mail: mike@globalsorl.com

Golden Dragon Auto Spare Parts (Dubai)

P.O. Box 56306, Dubai, U.A.E.
Tel: 00971-4-2278556
Fax: 00971-4-2278552
E-mail: sorl@emirate.net.ae

SORL Bulgaria Ltd. (Bulgaria)

West Industrial zone
Ex brewery factory
9000 Varna, Bulgaria
Tel: 0035-9899 193801
E-mail: g.petrov@sorl-europe.bg